

**KEITHLEY**

---

# Model 706 Scanner Instruction Manual

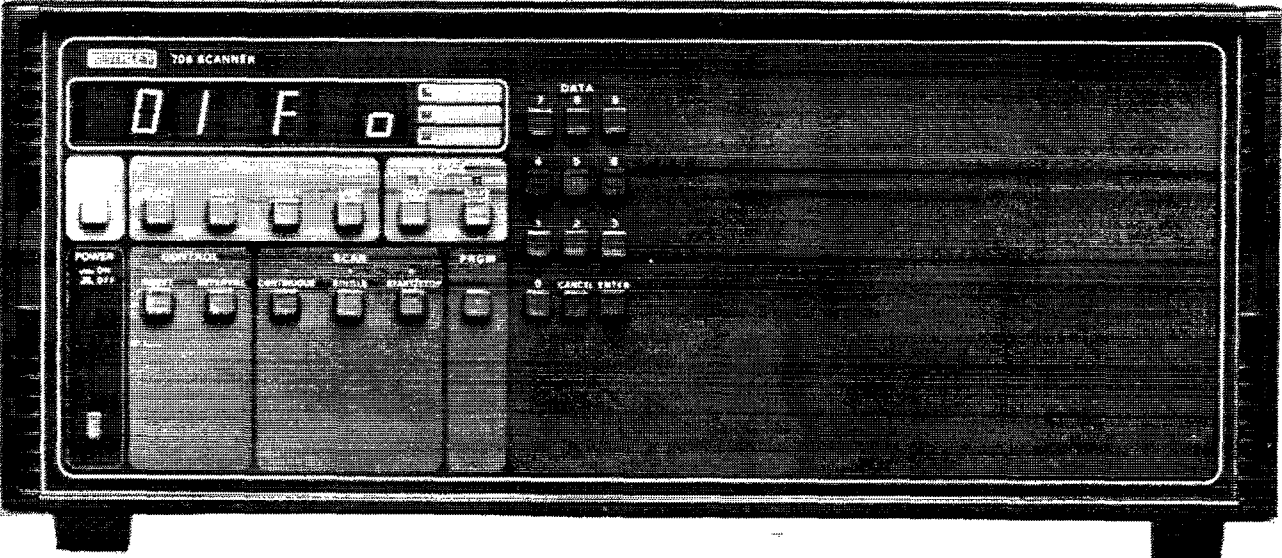

**Contains Operating and Servicing Information**

Publication Date: April 1991  
Document Number: 706-901-01 Rev. E

# WARRANTY

Keithley Instruments, Inc. warrants this product to be free from defects in material and workmanship for a period of 1 year from date of shipment.

Keithley Instruments, Inc. warrants the following items for 90 days from the date of shipment: probes, cables, rechargeable batteries, diskettes, and documentation.

During the warranty period, we will, at our option, either repair or replace any product that proves to be defective.

To exercise this warranty, write or call your local Keithley representative, or contact Keithley headquarters in Cleveland, Ohio. You will be given prompt assistance and return instructions. Send the product, transportation prepaid, to the indicated service facility. Repairs will be made and the product returned, transportation prepaid. Repaired or replaced products are warranted for the balance of the original warranty period, or at least 90 days.

## LIMITATION OF WARRANTY

This warranty does not apply to defects resulting from product modification without Keithley's express written consent, or misuse of any product or part. This warranty also does not apply to fuses, software, non-rechargeable batteries, damage from battery leakage, or problems arising from normal wear or failure to follow instructions.

THIS WARRANTY IS IN LIEU OF ALL OTHER WARRANTIES, EXPRESSED OR IMPLIED, INCLUDING ANY IMPLIED WARRANTY OF MERCHANTABILITY OR FITNESS FOR A PARTICULAR USE. THE REMEDIES PROVIDED HEREIN ARE BUYER'S SOLE AND EXCLUSIVE REMEDIES.

NEITHER KEITHLEY INSTRUMENTS, INC. NOR ANY OF ITS EMPLOYEES SHALL BE LIABLE FOR ANY DIRECT, INDIRECT, SPECIAL, INCIDENTAL OR CONSEQUENTIAL DAMAGES ARISING OUT OF THE USE OF ITS INSTRUMENTS AND SOFTWARE EVEN IF KEITHLEY INSTRUMENTS, INC., HAS BEEN ADVISED IN ADVANCE OF THE POSSIBILITY OF SUCH DAMAGES. SUCH EXCLUDED DAMAGES SHALL INCLUDE, BUT ARE NOT LIMITED TO: COSTS OF REMOVAL AND INSTALLATION, LOSSES SUSTAINED AS THE RESULT OF INJURY TO ANY PERSON, OR DAMAGE TO PROPERTY.



Keithley Instruments, Inc. • 28775 Aurora Road • Cleveland, OH 44139 • 216-248-0400 • Fax: 216-248-6168 • <http://www.keithley.com>

CHINA:	Keithley Instruments China • Yuan Chen Xin Building, Room 705 • No. 12 Yumin Road, Dewei, Madian • Beijing, China 100029 • 8610-2022886 • Fax: 8610-2022896
FRANCE:	Keithley Instruments SARL • BP 60 • 3 allée des Garays • 91122 Palaiseau Cédex • 31-6-0115155 • Fax: 31-6-0117726
GERMANY:	Keithley Instruments GmbH • Landsberger Straße 65 • 82110 Germering • 49-89-849307-0 • Fax: 49-89-84930759
GREAT BRITAIN:	Keithley Instruments, Ltd. • The Minster • 58 Portman Road • Reading, Berkshire RG30 1EA • 44-01734-575666 • Fax: 44-01734-596469
ITALY:	Keithley Instruments SRL • Viale S. Gimignano 38 • 20146 Milano • 39-2-48303008 • Fax: 39-2-48302274
JAPAN:	Keithley Instruments Far East KK • Aibido Bldg. • 7-20-2 Nishishinjuku • Shinjuku-ku, Tokyo 160 • 81-3-5389-1964 • Fax: 81-3-5389-2068
NETHERLANDS:	Keithley Instruments BV • Avelingen West 49 • 4202 MS Gorinchem • 31-(0)183-635333 • Fax: 31-(0)183-630821
SWITZERLAND:	Keithley Instruments SA • Kriesbachstrasse 4 • 8600 Dübendorf • 41-1-8219444 • Fax: 41-1-8203081
TAIWAN:	Keithley Instruments Taiwan • 1, Ming-Yu First Street • Hsinchu, Taiwan, R.O.C. • 886-35-778462 • Fax: 886-35-778455

# Model 706 Scanner Instruction Manual

©1983, Keithley Instruments, Inc.  
Test Instrumentation Group  
All rights reserved.  
Cleveland, Ohio, U.S.A.  
Fifth Printing, April 1991  
Document Number: 706-901-01 Rev. E

# SPECIFICATIONS

## GENERAL

**DISPLAY:** Seven 0.5" LED digits with decimal point, function and IEEE status annunciators.

**INTERNAL CLOCK:** Displays hours/minutes/seconds or date/month; less than 1 minute/month error (typical).

**BATTERY BACKUP:** Rechargeable 3.6V nickel-cadmium. 1 month retention of data with unit turned off.

**OPERATING ENVIRONMENT:** 0° to 50°C, 0% to 80% relative humidity up to 35°C.

**STORAGE ENVIRONMENT:** -25°C to 65°C.

**CONNECTORS:** Four BNC (TTL compatible): External Trigger, Alarm Out/Serial-In, Channel Ready, Serial Out.

**CAPACITY:** Ten plug-in cards per mainframe.

**EXPANSION CAPACITY:** Daisy chain allows up to 4 SLAVE units with 1 MASTER unit.

**SWITCHING RATE:** 100 channels/second (10ms), programmable to 1 channel/16 minutes (999.999s).

**RELAY DRIVE:** 4A minimum.

**POWER:** 90-125V or 195-250V (internally selected), 50Hz to 400Hz, 75V•A maximum.

**DIMENSIONS, WEIGHT:** 178mm high × 438mm wide × 448mm deep (7" × 17 1/4" × 17 3/8"). Net weight 8.6kg (19 lbs).

## ACCESSORIES AVAILABLE:

Model 7008-3: IEEE-488 Cable, 0.9m (3 ft.)

Model 7008-6: IEEE-488 Cable, 1.8m (6 ft.)

Model 7010: IEEE-488 Adapter for Model 85 Computer.

Model 7024-1: Triaxial Cable, 0.3m (1 ft.)

Model 7024-3: Triaxial Cable, 0.9m (3 ft.)

Model 7024-10: Triaxial Cable, 3.0m (10 ft.)

Model 7051-2: BNC to BNC Cable, 0.6m (2 ft.)

Model 7051-5: BNC to BNC Cable, 1.5m (5 ft.)

Model 7052: 4 × 5 Matrix Card

Model 7053: High Current Scanner Card

Model 7054: High Voltage Scanner Card

Model 7056: General Purpose Scanner Card

Model 7057A: Thermocouple Scanner Card

Model 7058: Low Current Scanner Card

Model 7059: Low Voltage Scanner Card

Model 7061: Universal Interface Card

Model 7068: Fixed Rack Mounting Kit for 706

Model 7069: Slide Rack Mounting Kit for 706

## IEEE-488 BUS IMPLEMENTATION:

**Multiline Commands:** DCL, LLO, SDC, GET, GTL, UNT, UNL, SPE, SPD.

**Uniline Commands:** IFC, REN, EOI, SRQ, ATN.

**Interface Functions:** SH1, AH1, T6, TE0, L4, LE0, SR1, RL1, PP0, DC1, DT1, C0, E1.

**Programmable Parameters:** Display Mode, Output Format, EOI, SRQ, First\_Last, Open, Close, Display Channel, Alternate Output, Pole Mode, Date Format, Save/Recall, Reset, I/O Port, Time, Date, Settle Time, Interval Time, Alarm Time, Program Mode, Trigger Mode, Terminator, Self Test.

**Digital I/O Port:** A separate edge connector consisting of eight input and eight output lines as well as common and +5VDC. Outputs will drive one TTL load. Inputs represent one TTL load. Mating connector supplied.

## FRONT PANEL PROGRAMS

<b>0 - Digital I/O</b>	Read or change state on digital I/O port.
<b>1* - Date Format</b>	Changes date display between MM.DD and DD.MM.
<b>2* - Settle Time</b>	Time to output CHANNEL READY pulse after closing relay.
<b>3* - IEEE Address</b>	Set bus address; not programmable from bus.
<b>4* - Save Setup</b>	Stores present relay setup in buffers 1-75.
<b>5* - Recall Setup</b>	Recalls relay setup in buffers 1-75.
<b>6* - Poles</b>	1, 2, or 4-pole configuration for scanning (1-pole requires 7056). 0-pole for matrix card.
<b>7 - Alarm Time</b>	Set time for Alarm output pulse; repeats daily.
<b>8 - Self Test</b>	Check RAM, ROM, LEDs.
<b>90* - Stand Alone</b>	Single 706 configuration.
<b>91* - Master</b>	Daisy Chain configuration.
<b>92* - Slave</b>	Daisy Chain configuration.
<b>93 - Inspect</b>	Display closed relays only.
<b>94 - Clear</b>	Clear buffer location.
<b>99 - Reset</b>	Reset battery backup parameters to factory values.

\*Battery backed up.

# Safety Precautions

---

The following safety precautions should be observed before using this product and any associated instrumentation. Although some instruments and accessories would normally be used with non-hazardous voltages, there are situations where hazardous conditions may be present.

This product is intended for use by qualified personnel who recognize shock hazards and are familiar with the safety precautions required to avoid possible injury. Read the operating information carefully before using the product.

Exercise extreme caution when a shock hazard is present. Lethal voltage may be present on cable connector jacks or test fixtures. The American National Standards Institute (ANSI) states that a shock hazard exists when voltage levels greater than 30V RMS, 42.4V peak, or 60VDC are present. **A good safety practice is to expect that hazardous voltage is present in any unknown circuit before measuring.**

Before operating an instrument, make sure the line cord is connected to a properly grounded power receptacle. Inspect the connecting cables, test leads, and jumpers for possible wear, cracks, or breaks before each use.

For maximum safety, do not touch the product, test cables, or any other instruments while power is applied to the circuit under test. **ALWAYS** remove power from the entire test system and discharge any capacitors before: connecting or disconnecting cables or jumpers, installing or removing switching cards, or making internal changes, such as installing or removing jumpers.

Do not touch any object that could provide a current path to the common side of the circuit under test or power line (earth) ground. Always make measurements with dry hands while standing on a dry, insulated surface capable of withstanding the voltage being measured.

Do not exceed the maximum signal levels of the instruments and accessories, as defined in the specifications and operating information, and as shown on the instrument or test fixture panels, or switching card.

Do not connect switching cards directly to unlimited power circuits. They are intended to be used with impedance limited sources. **NEVER** connect switching cards directly to AC main. When connecting sources to switching cards, install protective devices to limit fault current and voltage to the card.

When fuses are used in a product, replace with same type and rating for continued protection against fire hazard.

Chassis connections must only be used as shield connections for measuring circuits, **NOT** as safety earth ground connections.

If you are using a test fixture, keep the lid closed while power is applied to the device under test. Safe operation requires the use of a lid interlock.

If a  screw is present, connect it to safety earth ground using #18 AWG or larger wire.

The  symbol on an instrument or accessory indicates that 1000V or more may be present on the terminals. Refer to the product manual for detailed operating information.

Instrumentation and accessories should not be connected to humans.

Maintenance should be performed by qualified service personnel. Before performing any maintenance; disconnect the line cord and all test cables.

# TABLE OF CONTENTS

Paragraph	Title	Page
<b>SECTION 1—GENERAL INFORMATION</b>		
1.1	Introduction .....	1-1
1.2	Model 706 Features .....	1-1
1.3	Warranty Information .....	1-1
1.4	Manual Addenda .....	1-1
1.5	Safety Symbols and Terms .....	1-1
1.6	Unpacking and Inspection .....	1-1
1.7	Specifications .....	1-1
1.8	Optional Accessories .....	1-2
1.9	Repacking for Shipment .....	1-3
 <b>SECTION 2—OPERATION</b>		
2.1	Introduction .....	2-1
2.2	Preparation for Use .....	2-1
2.2.1	Correct Line Voltage .....	2-1
2.2.2	Plug-In Card (Scanner) Installation .....	2-1
2.3	Power Up .....	2-2
2.4	Environmental Condition .....	2-3
2.5	Operating Instructions .....	2-3
2.5.1	Front Panel Controls .....	2-3
2.5.2	Rear Panel Description .....	2-3
2.5.3	Basic Front Panel Operation .....	2-7
2.5.4	Scanning Examples .....	2-8
2.6	Front Panel Clock Operation .....	2-13
2.7	Detailed Front Panel Controls Description .....	2-14
2.8	Detailed Rear Panel Description .....	2-17
2.9	Front Panel Programs .....	2-18
2.9.1	Program 0 Digital I/O .....	2-19
2.9.2	Program 1 Data Format .....	2-19
2.9.3	Program 2 Relay Settle Time .....	2-20
2.9.4	Program 3 Set IEEE Primary Address .....	2-20
2.9.5	Program 4 Save Relay Set Up .....	2-21
2.9.6	Program 5 Recall Relay Set Up .....	2-21
2.9.7	Program 6 Pole Configuration, Matrix Mode .....	2-22
2.9.8	Program 7 Set Alarm Time .....	2-24
2.9.9	Program 8 Diagnostic Self Test .....	2-25
2.9.10	Program 90 Stand Alone .....	2-25
2.9.11	Program 91 Master .....	2-25
2.9.12	Program 92 Slave .....	2-26
2.9.13	Program 93 Inspect .....	2-26
2.9.14	Program 94 Clear .....	2-27
2.9.15	Program 99 Reset .....	2-28
 <b>SECTION 3—IEEE BUS OPERATION</b>		
3.1	Introduction .....	3-1
3.1.1	Software Consideration .....	3-1
3.1.2	HP-85 BASIC Statements .....	3-1
3.1.3	Interface Function Codes .....	3-2
3.1.4	Mode 706 Interface Commands .....	3-3
3.2	IEEE-488 Bus Lines .....	3-3
3.2.1	Bus Management Lines .....	3-3
3.2.2	Handshake Lines .....	3-4
3.2.3	Data Lines .....	3-4
3.3	System Set Up Procedure .....	3-4

3.4	Bus Commands .....	3-5
3.4.1	Uniline Commands .....	3-5
3.4.2	Universal Commands .....	3-6
3.4.3	Addressed Commands .....	3-7
3.5	Device-Dependent Commands .....	3-8
3.5.1	Display Mode .....	3-13
3.5.2	Program (Scan) Mode .....	3-14
3.5.3	Prefix .....	3-15
3.5.4	EOI (End or Identify) .....	3-16
3.5.5	Bus Response Mode (SRQ) .....	3-16
3.5.6	Trigger Modes .....	3-18
3.5.7	Programmable Terminator (Y) .....	3-18
3.5.8	Inputs .....	3-19
3.6	Status Byte Format .....	3-27
3.7	Status Word (U) .....	3-28
3.8	Front Panel Programs .....	3-29
3.9	Front Panel Error Messages .....	3-29
3.9.1	IDDC Error .....	3-29
3.9.2	No Remote Error .....	3-29
3.9.3	IDDCO Error .....	3-29
3.10	Scanning Program .....	3-29

#### SECTION 4—THEORY OF OPERATION

4.1	Introduction .....	4-1
4.2	Power Supply .....	4-1
4.3	Microcomputer .....	4-1
4.4	Display Circuit .....	4-3
4.5	IEEE-488 Interface Circuitry .....	4-3

#### SECTION 5—MAINTENANCE

5.1	Introduction .....	5-1
5.2	Fuse Replacement .....	5-1
5.3	Line Voltage Selection .....	5-1
5.4	Disassembly .....	5-3
5.5	Troubleshooting .....	5-6
5.5.1	Recommended Test Equipment .....	5-6
5.5.2	Digital Self Test .....	5-6
5.5.3	Power Supply Checks .....	5-7
5.5.4	Digital Circuitry Checks .....	5-7
5.5.5	Display Boards Check .....	5-7
5.5.6	Interconnect Board Checks .....	5-8
5.6	Battery Charge .....	5-8
5.7	Special Handling of Static Sensitive Devices .....	5-8

#### SECTION 6—REPLACEABLE PARTS

6.1	Introduction .....	6-1
6.2	Parts List .....	6-1
6.3	Ordering Information .....	6-1
6.4	Factory Service .....	6-1
6.5	Component Location Drawings and Schematic Diagrams .....	6-1

## LIST OF FIGURES

Figure	Title	Page
1-1	Model 706 Scanner .....	1-0
2-1	Scanner Card Installation .....	2-2
2-2	Front Panel Control .....	2-4
2-3	Model 706 Rear Panel .....	2-6
2-4	Daisy Chain Configuration .....	2-11
2-5	Model 7052 Matrix Scheme .....	2-23
2-6	Matrix Display Clarification .....	2-24
3-1	Bus Structure .....	3-3
3-2	Handshake Sequence .....	3-4
3-3	Contact Assignments .....	3-5
3-4	Typical Bus Connector .....	3-5
3-5	Digital I/O Port Pin Assignment .....	3-24
3-6	U and G Mode Sequence .....	3-27
3-7	Status Byte Format .....	3-28
3-8	Status Word Format .....	3-28
3-9	IEEE Display Error Messages .....	3-29
4-1	Model 706 Block Diagram .....	4-2
4-2	Model 706 Memory Map .....	4-3
5-1	Top and Bottom Cover Removal .....	5-2
5-2	Power Supply Exploded View .....	5-4
5-3	Model 706 Top View .....	5-5
6-1	Display Board, Component Location Drawing, Dwg. No. 706-110 .....	6-9
6-2	Digital I/O Board, Component Location Drawing, Dwg. No. 706-170 .....	6-10
6-3	Mother Board, Component Location Drawing, Dwg. No. 706-110 .....	6-11/6-12
6-4	Interconnect Board, Component Location Drawing, Dwg. No. 706-160 .....	6-15/6-16
6-5	Display Board, Schematic Diagram, Dwg. No. 705-116 .....	6-17/6-18
6-6	Digital I/O Board, Schematic Diagram, Dwg. No. 706-176 .....	6-19/6-20
6-7	Mother Board, Schematic Diagram, Dwg. No. 706-106 .....	6-21/6-22
6-8	Interconnect Board, Schematic Diagram, Dwg. No. 706-166 .....	6-25/6-26

## LIST OF TABLES

Table	Title	Page
2-1	Line Voltage Setting .....	2-1
2-2	Slot Number/Channel Number Assignment .....	2-1
2-3	Power Up Default Conditions (Front Panel Operation) .....	2-3
2-4	Front Panel Controls .....	2-5
2-5	Rear Panel Description .....	2-7
2-6	Step Scan Example .....	2-8
2-7	Single Scan Example .....	2-9
2-8	Continuous Scan Example .....	2-10
2-9	Required Equipment for Daisy Chain Example .....	2-10
2-10	Daisy Chain Example .....	2-11
2-11	Temperature Scan Example .....	12-12
2-12	Low Current Scan Example .....	2-13
2-13	Setting the Time .....	2-13
2-14	Setting the Date .....	2-14
2-15	Maximum Relay Drive Current from Mainframe .....	2-15
2-16	CANCEL Function Example .....	2-16
2-17	Summary of Front Panel Programs .....	2-19
2-18	Scanner Card Pole Configuration .....	2-22
2-19	Matrix Unit Number Display Assignment .....	2-24



## LIST OF TABLES (CONT.)

2-20	Matrix Card Number Display Assignment .....	2-24
2-21	Program 99 Reset Condition .....	2-29
3-1	HP-85 IEEE-488 BASIC Statements .....	3-2
3-2	Model 706 Interface Function Codes .....	3-3
3-3	IEEE Command Groups .....	3-3
3-4	IEEE Bus Connector Contact Designations .....	3-5
3-5	Power Up, DCL and SDC Default Conditions .....	3-6
3-6	Device-Dependent Commands Not Available to the Front Panel .....	3-9
3-7	Model 706 Device-Dependent Commands .....	3-10
3-8	Hierarchy of Command Execution .....	3-12
3-9	SRQ Commands and Conditions .....	3-16
3-10	Digital I/O Port Contact Pin Assignments .....	3-24
5-1	Fuse Replacement 3AG Size .....	5-1
5-2	Fuse Replacement 5mm Size .....	5-1
5-3	Line Voltage Selection .....	5-1
5-4	Recommended Test Equipment .....	5-6
5-5	Power Supply Checks .....	5-6
5-6	Digital Circuitry Checks .....	5-7
5-7	Display Board Checks .....	5-7
5-8	Interconnect Board Checks .....	5-8
5-9	Model 706 Static Sensitive Devices .....	5-8
6-1	Model 706 Recommended Spare Parts List .....	6-1
6-2	Index of Model 706 Schematics and Component Layouts .....	6-1
6-3	Display Board Parts List .....	6-2
6-4	Mother Board Parts List .....	6-3
6-5	Digital I/O Board Parts List .....	6-5
6-6	Interconnect Board Parts List .....	6-6
6-7	Model 706 Mechanical Parts List .....	6-7

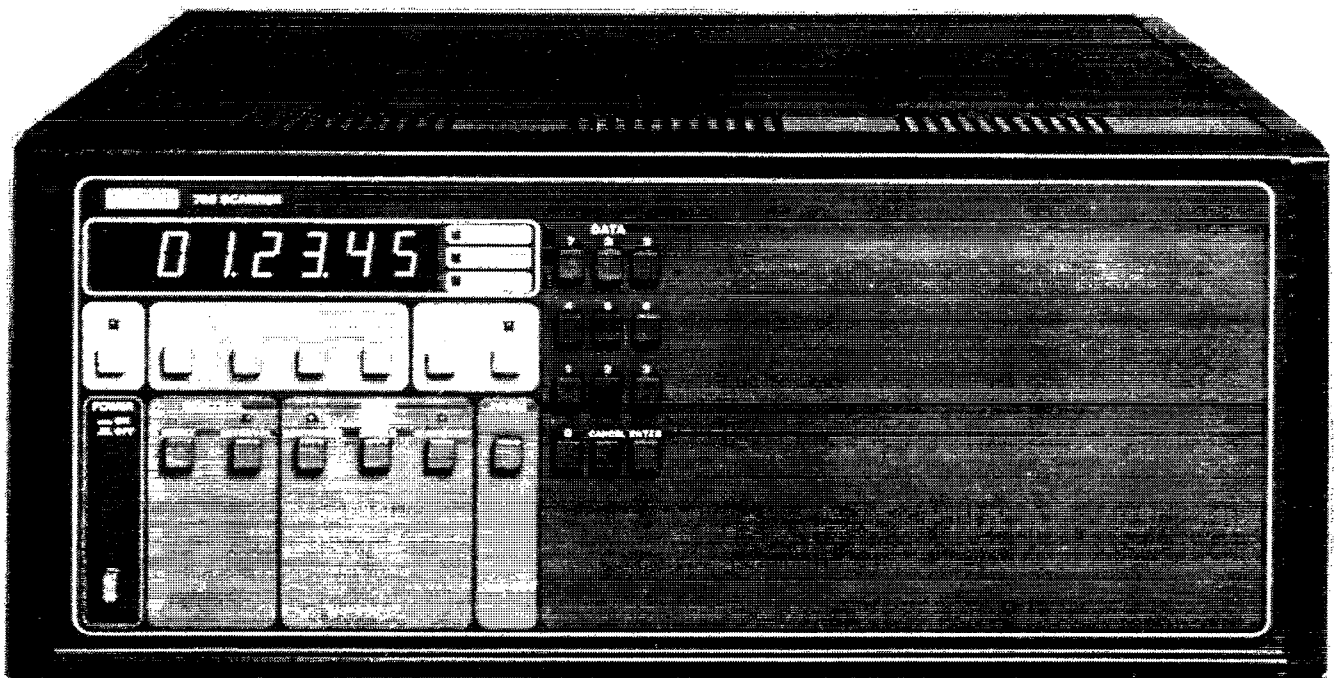

Figure 1-1. Model 706 Scanner

# SECTION 1

## GENERAL INFORMATION

### 1.1 INTRODUCTION

The Model 706 is an IEEE-488 bus compatible scanner that can accommodate ten plug-in scanner cards. With ten scanner cards installed up to 100 2-pole channels can be on the same IEEE address. Using four additional Model 706s in a daisy chain configuration up to 500 2-pole channels can be on the same IEEE address. The Model 706 scanner adheres to standard IEEE-488 interface bus protocol. This enables the Model 706 to be incorporated into any measurement that uses programmed control through the IEEE-488 bus.

The front panel controls are clearly marked and easy to use. These controls serve several functions such as opening a selected channel, closing the channel, scanning between a selectable first and last channel, selecting scan rate and mode. There are 15 internal programs that are accessible from the front panel. The programs can select primary address, settling time, store a relay set up, recall the stored relay set up, control the digital I/O port, switch from International to American date format, start or stop a scan sequence, select 1, 2 or 4-pole measurement modes and program the Model 706 as a master, slave or stand alone instrument in a daisy chain configuration. The Model 706 may also be operated in a matrix configuration.

The time and date are kept internally with a battery backed up clock allowing time dependent procedures to be performed.

### 1.2 MODEL 706 FEATURES

The Model 706 scanner includes the following features:

- Up to 100 2-pole channels.
- IEEE-488 bus operation.
- Selectable scan rate of 10msec to 999.999sec.
- Selectable scan modes that enable the user to scan the first channel to the last channel once, continuously or manually.
- Fifteen internal programs that are accessible from the front panel.
- Model 706 mainframe can accommodate 10 scanner plug-in cards.
- Several different plug-in scanner cards are available as options. They include: a general purpose relay card, a thermocouple card, low voltage card, low current card, high current card, high voltage card, matrix card and universal interface card.
- Time and date are kept with a battery backed up clock.
- Digital I/O port with eight lines as inputs and eight lines as outputs.
- External trigger input that accepts a greater than  $2\mu\text{sec}$  negative going TTL compatible pulse for triggering the Model 706 into a scan sequence.
- Channel ready output that outputs a greater than  $10\mu\text{sec}$  negative going TTL compatible pulse upon the completion

of the programmed channel settling time.

- Alarm output that outputs a negative going TTL level greater than  $10\mu\text{sec}$  pulse when the programmed time is reached.

### 1.3 WARRANTY INFORMATION

Warranty information is provided on the inside front cover of this manual. If there is a need to exercise the warranty, contact your Keithley representative in your area to determine the proper action to be taken. Keithley maintains complete repair and calibration facilities in the United States, West Germany, Great Britain, France, the Netherlands, Switzerland and Austria. Information may be directed to the applications engineer at any of the above locations. Check the inside front cover of this manual for addresses.

### 1.4 MANUAL ADDENDA

Improvements or changes to this manual will be explained on an addendum included with this manual.

### 1.5 SAFETY SYMBOLS AND TERMS

Safety symbols used in this manual are as follows:

The symbol  on the instrument denotes that the user should refer to the operating instructions.

The symbol  on the instrument denotes that high voltage may be present on the terminals.

The **WARNING** used in this manual explains dangers that could result in personal injury or death.

The **CAUTION** used in this manual explains hazards that could damage the instrument.

### 1.6 UNPACKING AND INSPECTION

The Model 706 is inspected both electrically and mechanically before shipment. Upon receiving the Model 706, unpack all items from the shipping container and check for any obvious damage that may have occurred during transit. Report any damage to the shipping agent. Retain and use the original packaging materials if reshipment is necessary. The following items are shipped with all Model 706 orders:

- Model 706 Scanner
- Model 706 Instruction Manual
- Optional accessories per request. (Cards are shipped separately.)

### 1.7 SPECIFICATIONS

For Model 706 detailed specifications, refer to the specifications that precede this section.



## 1.8 OPTIONAL ACCESSORIES

**Switching Cards** — Keithley offers over 20 different models of switching cards. In addition to general purpose scanning and matrix applications, cards are designed for special applications with signal handling capabilities that include:

- Low voltage switching to 20nV.
- Low current switching to 10fA.
- High frequency switching to 500MHz.
- Thermocouple switching with a precision temperature reference.
- High voltage switching to 1000V.

Further details on switching cards can be obtained by contacting a Keithley representative or sales office.

**Model 7008-3 IEEE-488 Cable** — The Model 7008-3 is a 1 meter (3 feet) IEEE-488 cable. The cable has 24 stranded wire conductors and is terminated on each end with IEEE-488 standard connectors.

**Model 7008-6 IEEE-488 Cable** — The Model 7008-6 is a 2 meter (6 feet) IEEE-488 cable. The cable has 24 stranded wire conductors and is terminated on each end with IEEE-488 standard connectors.

**Model 7010 Cable Adapter** — The Model 7010 is an IEEE-488 cable adapter. The adapter extends the IEEE-488 connector by one connector width.

**Model 7051-2** — The Model 7051-2 is a (2 feet) BNC to BNC cable. It is especially useful for daisy chain operation.

**Model 7051-5** — The Model 7051-5 is a (5 feet) BNC to BNC cable. It is especially useful daisy chain configuration.

**Model 7068 Fixed Rack Mount** — The Model 7068 is a fixed or stationary rack mounting kit that mounts the Model 706 in a standard 19 inch rack. The dimensions are 13-3/4 inches deep × 7 inches high (350mm × 178mm).

**Model 7069 Slide Rack Mount with Handles** — The Model 7069 is a sliding rack mount kit. It enables one Model 706 to be rack mounted with the added feature of sliding the instrument for easy access. The dimensions are 3-3/4 inches deep × 7 inches high (95mm × 178mm).

## 1.9 REPACKING FOR SHIPMENT

The Model 706 should be packed in its original carton. Before packing, wrap the instrument in plastic. After it is placed in the box, surround the instrument with styrofoam packaging material. Remove all cards and ship separate.

If the Model 706 is to be returned to Keithley Instruments for calibration or repair, include the following:

- Write ATTENTION REPAIR DEPARTMENT on the address label.
- Include the warranty status of the instrument.
- Photocopy and complete the service form at the back of this manual and return it with the instrument.



## SECTION 2 OPERATION

### 2.1 INTRODUCTION

Operation of the Model 706 is divided into two sections: front panel operation and IEEE-488 bus operation. IEEE bus operation is located in Section 3. This section contains the following information:

- Preparation for use
- Power Up
- Environmental Conditions
- Front and Rear Panels Description
- Examples of Scanning
- Front Panel Programs

### 2.2 PREPARATION FOR USE

#### 2.2.1 Correct Line Voltage

Connect the Model 706 to the proper power receptacle (refer to Table 2-1). For fuse replacement or line voltage setting refer to Section 5 Maintenance.

#### WARNING

**Ground the instrument through a properly earth grounded receptacle before operation. Failure to ground the instrument can result in severe injury or death in the event of a short circuit or malfunction.**

#### 2.2.2 Plug-In Card (Scanner) Installation

Before operating the Model 706, the appropriate scanner cards must be installed into the mainframe. Each scanner card (up to 10 cards per the Model 706 mainframe) is installed in the appropriate vertical slot in the rear panel of the Model 706. Refer to Figure 2-1 for an overall picture of scanner card installation.

#### WARNING

**To prevent a possible shock hazard, turn the instrument off and disconnect the line cord before installing/removing any scanner card.**

1. To install a scanner card, slide the card into the appropriate vertical slot. The slots are numbered 1 through 10. Refer to Table 2-2 for slot number/ channel numbers assignment. Facing the rear panel of the Model 706, the scanner card component side should face the left side of the slot. Make certain the card edges are aligned with the top and bottom grooves in the slot.
2. Once the card is aligned with the grooves, insert the card to its full depth into the Model 706. Make certain the card is properly seated into the connector on the interconnect board. When the card is fully inserted, the locking tabs on the card should be placed in the locked position as shown in Figure 2-1.
3. To remove a scanner card, first turn the Model 706 off and disconnect the line cord. Unfasten the locking tabs by pulling both tabs outward. Grasp the end of the card and pull it out of the mainframe.

#### NOTE

Handle the scanner cards by the edges to avoid contaminating them with dirt, body oil, etc.

#### WARNING

**Do not insert scanner cards that have metal clamps into the Model 706. Otherwise a shock hazard will be present. Only use scanner cards that have plastic clamps.**

**Table 2-2. Slot Number Channel Number Assignment**

Slot Number	Channels Included
1	1-10
2	11-20
3	21-30
4	31-40
5	41-50
6	51-60
7	61-70
8	71-80
9	81-90
10	91-100

\*Does not include other units in a daisy chain configuration see paragraph 2.5.4 example 4.

**Table 2-1. Line Voltage Setting**

Input Voltage	Jumper Setting	Line Fuse		F101	Varistor VR2
		3AG	5mm		
90V-125V	Installed	1.25A, 250V	1.25A, 250V	installed	installed
195V-250V	Not Installed	0.6A, 250V	0.6A, 250V	not installed	not installed

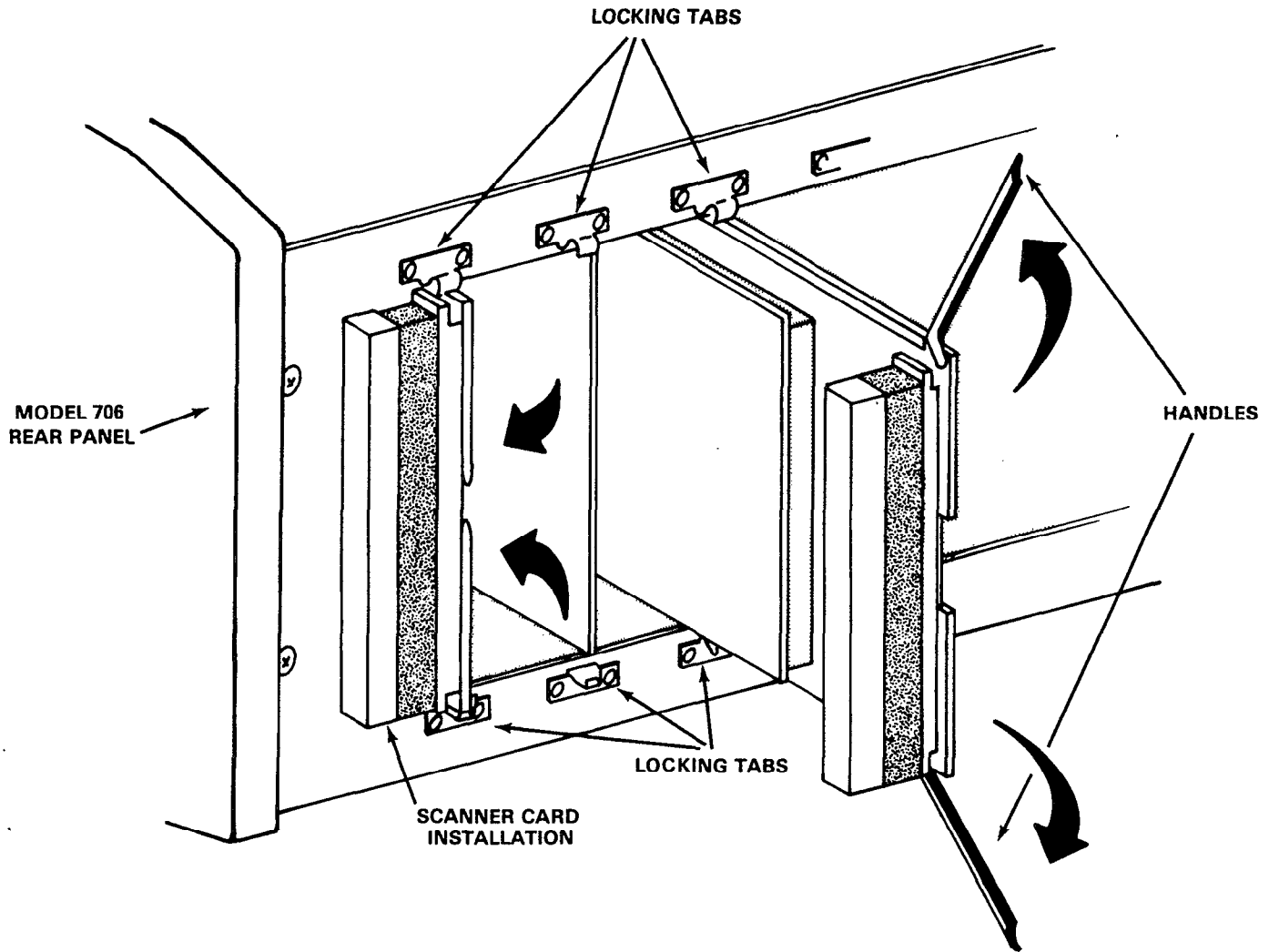
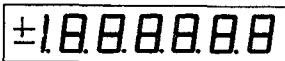

Figure 2-1. Scanner Card Installation

### 2.3 POWER UP

When the Model 706 is turned on the instrument goes through a power up sequence that is outlined as follows:

Immediately after turning on the Model 706 via the power switch, the display indicates the following for a number of seconds:



1. This is a display test. The operator can note inoperative display segments by comparing the Model 706's display with the figure above.
2. In addition, the pushbutton and the TALK, LISTEN and REMOTE indicators turn on. All indicators turn on simultaneously if operating correctly.

After the display test is complete, the Model 706 displays the software revision level for approximately 0.5 seconds. The following is an example of software revision level A1.



After the software revision level is displayed, the Model 706 displays the primary address of the instrument for approximately 0.5 seconds. The primary address of the Model 706 is factory set at 18.

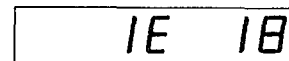

During the display test the Model 706 performs a digital self test of the RAM circuitry and a cyclic redundancy check (CRC) of the ROM circuitry. If a problem is found by these tests the Model 706 displays a diagnostic number. This number and its meaning is described in detail in Section 5.

After all the displays and test of the power up sequence, the Model 706 comes to the default conditions that are listed in Table 2-3.

#### NOTE

If upon power up the Model 706 displays the slave or no loop message (refer to paragraphs 2.9.11 and 2.9.12) activate Program 90 to return the Model 706 to normal operating conditions. To activate Program 90, press PRGM, 9, 0.

**Table 2-3. Power Up Default Conditions (Front Panel Operation)**

Function or Program	Default Conditions
CHANNEL	Channel mode is selected, channel 1 is displayed and all channels are open.*
TIME	Time is not affected by power up.
DATE	Date is not affected by power up.
RESET	Reset is not affected by power up.
INTERVAL	Interval time is not affected by power up.
SINGLE	Single scan mode is set to inactive.
CONTINUOUS	Continuous scan mode is set to inactive.
START/STOP	Start/Stop function is set to stop.
Program 0	Digital I/O outputs are set to 000, the inputs are not affected by power up.
Program 1	Date format is not affected by power up.
Program 2	Settle time is not affected by power up.
Program 3	Primary address is not affected by power up.
Program 4	Save relay set up is cleared from display but still in memory. Channel 1 is displayed.
Program 5	Recall relay set up is cleared from display but still in memory. Channel 1 is displayed.
Program 6	Number of poles is not affected by power up.
Program 7	Alarm time is set to 00.00.00.
Program 8	Self test is not activated.
Program 90	Program 90 is not affected by power up.
Program 91	Program 91 is not affected by power up.
Program 92	Program 92 is not affected by power up.
Program 93	Program 93 is set to inactive.
Program 94	Program 94 is not affected by power up.
Program 99	Program 99 is not affected by power up.
FIRST	The first function is not affected by power up.
LAST	The last function is not affected by power up.
CLOSE	All channels are open.
OPEN	All channels are open.

\*If channel 1 was previously programmed as the first channel, last channel, both or neither, it is displayed as such. The FIRST and LAST functions are not affected by power up.

To identify the previous state of the functions that are not affected by power up simply activate the desired function. When the function is activated the previous state for that function is displayed. Refer to paragraph 2.5.1 for information concerning the actuation of the desired function.

## 2.4 ENVIRONMENTAL CONDITIONS

All operation of the Model 706 should take place at an ambient temperature within the range of 0°C to 50°C, up to 35°C at 80% noncondensing relative humidity. Environmental conditions for storage are -25°C to +65°C.

### NOTE

If the Model 706 internal operating temperature is higher than 75°C the thermal breaker on the power supply will open up. This action will shut down the Model 706. Refer to Section 5 paragraph 5.5.3.

## 2.5 OPERATING INSTRUCTIONS

### 2.5.1 Front Panel Controls

Table 2-4 lists all the front panel controls and buttons. Their operation and function are briefly described in the table. For complete details concerning the front panel controls refer to paragraph 2.7. Refer to Figure 2-2 for a view of the front panel controls.

### 2.5.2 Rear Panel Description

Table 2-5 lists all the rear panel connectors and terminals. Their function and operation are briefly described in the table. For complete details concerning the rear panel refer to paragraph 2.8. Refer to Figure 2-3 for a view of the Model 706 rear panel.

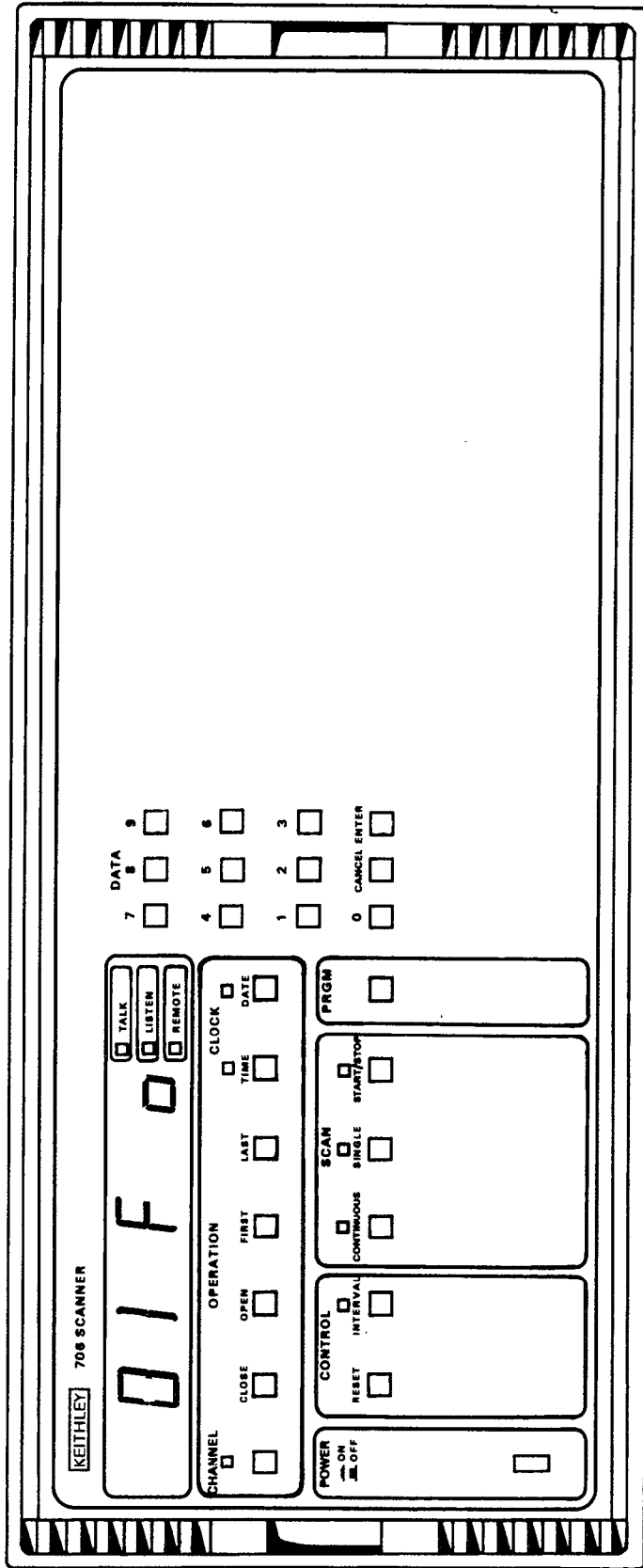

Figure 2-2. Front Panel Controls



**Table 2-4. Front Panel Controls**

<b>Control</b>	<b>Description</b>
POWER ON/OFF CHANNEL	Turns the unit on or off. Selects channel mode, turns on the channel LED and displays channel information (e.g. open or closed, first or last). Increments channel number by one each time it is activated when in the channel mode.
CLOSE	When activated the CLOSE button closes the presently displayed channel. Close is indicated by a c on the far right digit of the display.
OPEN	When activated the OPEN button opens the presently displayed channel. Open is indicated by an o on the far right digit of the display.
FIRST	When activated the FIRST button specifies the presently displayed channel as the first channel of a multi channel configuration. First is indicated by an F in the middle of the display.
LAST	When activated the LAST button specifies the presently displayed channel as the last channel of a multi channel configuration. Last is indicated by an L on the display.
RESET	When activated the RESET button opens all channels and reverts the display to the specified first channel.
INTERVAL	The INTERVAL button selects the programmed interval time for display and turns on the interval LED. The interval time is the programmed time each channel is closed in a scanning sequence.
CONTINUOUS	The CONTINUOUS button selects the continuous scan mode and turns on the continuous LED. The continuous scan mode allows the user to scan through the programmed channels in a continuous cycle upon the actuation of the START/STOP button.
SINGLE	The SINGLE button selects the single scan mode and turns on the SINGLE LED. The single scan mode allows the user to scan through the programmed channels one time upon the actuation of the START/STOP button.
START/STOP	The START/STOP button when activated initiates the selected scan mode and turns on the START/STOP LED. Pressing the button during a scan stops the scan sequence and turns off the START/STOP LED. When not in the continuous or single scan modes the START/STOP button activates the STEP scan mode. Refer to paragraph 2.5.4.
PRGM	The PRGM (Program) button when activated shows a display that prompts the user to select one of the 15 front panel programs. Refer to paragraph 2.9 for complete details and examples of the front panel programs.
DATA ENTER	The 0-9 buttons allow entry of numerical data onto the display. The ENTER button loads the displayed data for the interval time, channel number, time, date and program modes into the Model 706.
CANCEL	During the entry of data (C segment cursor is flashing) the CANCEL button cancels the present display and reverts the instrument to the previous display.
TIME	When activated the TIME button selects for display the 24 hour time clock and turns on TIME LED.
DATE	When activated the DATE button selects the date mode for display and turns on the DATE LED.
TALK*	When lit the TALK LED indicates that the Model 706 is in the talk mode.
LISTEN*	When lit the LISTEN LED indicates that the Model 706 is in the listen mode.
REMOTE*	When lit the REMOTE LED indicates that the Model 706 is in the remote mode.

\*Refer to Section 3 IEEE-488 bus operation.



**Table 2-5. Rear Panel Description**

Connections	Description
Card Slots	Each slot accepts one scanner card. There are a total of 10 slots.
SER. OUT	The serial output connector is a female BNC connector that provides connection to another Model 706 for a daisy chain configuration.
ALARM/SERIAL IN	The alarm function of this female BNC connector outputs a pulse when the programmed alarm time is reached. The serial in function is used in a daisy chain configuration where serial in is connected to the serial out of another Model 706.
CHANNEL READY	This female BNC connector outputs a pulse at the completion of the programmed channel settling time.
EXT. TRIGGER	This is a female BNC connector that initiates the selected scan mode upon receiving the proper signal pulse.
DIGITAL I/O	The digital I/O port consists of 16 digital input/output lines along with four lines that are +5V and IEEE common.
IEEE-488 INTERFACE CONNECTOR	This standard connector provides connection to the IEEE-488 bus.
FUSE	The line power fuse provides protection for the AC power line input and is rated as shown in Table 2-1.
AC Power Receptacle	The line power receptacle mates with three wire line cord and applies the line power to the instrument.

**2.5.3 Basic Front Panel Operation**

This section provides the information necessary for basic front panel operation of the Model 706. There are a number of steps to follow in order to get the Model 706 ready for scanning operation. These steps are as follows:

1. Install the desired scanner card(s). Refer to paragraph 2.2.2 for information concerning the installation of the scanner cards into the Model 706.
2. Select appropriate line voltage. Refer to Section 5 Maintenance for information concerning the selection of appropriate line voltage and proper fuse rating.
3. Turn on the Model 706. The instrument then goes through the power up sequence that is described in paragraph 2.3 and displays one of the following:

 (Normal Condition)

 (Matrix Mode, Refer to Paragraph 2.9.7)

**NOTE**

If upon power up the Model 706 displays the slave or no loop message (refer to paragraphs 2.9.11 and 2.9.12) activate Program 90 to return the Model 706 to normal operating conditions. To activate Program 90, press PRGM, 9, 0.

**NOTE**

Channel 1 is set as the programmed first channel. If another channel was previously programmed as the first or last channel, then the F or L will not be displayed upon power up.

4. Program the desired channel. (Channel mode is selected upon power up).

- A. Select the first channel.

1. Press the desired channel number from the DATA group buttons 0-9.
2. Press the FIRST button to program the presently displayed channel as the first channel.

**NOTE**

Selecting a channel that does not exist in the present set up causes the Model 706 to display the following message.

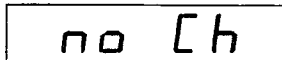

- B. Select the last channel.

1. Press the desired number from the DATA group button 0-9.
2. Press the LAST button to program the presently displayed channel as the last channel.

5. Program the number of poles (0, 1, 2 or 4).

- A. Press PRGM.
- B. Press 6.
- C. Select number of poles (0, 1, 2 or 4).
- D. Press ENTER.

**NOTE**

The 0 pole mode is the matrix mode. Refer to paragraph 2.9.7 for complete details concerning programming of the different poles.

6. Program the interval time.

- A. Press the INTERVAL button to select interval mode for display.
- B. Enter the interval time on the display by pressing from

the DATA group the desired time, within the limits of 000.010 to 999.999 seconds.

C. Press the ENTER button.

7. Program the desired scan mode. Press the SINGLE or CONTINUOUS button to select one of these two scanning modes. To select the step scan mode press the CHANNEL button.

8. Press the START/STOP button to start the scanning sequence. For the step mode press the START/STOP button each time a single channel is to be scanned.

The previous steps 1 through 8, show a general procedure to get the Model 706 into a scanning sequence. Paragraph 2.5.4 shows how to use the different scan modes, how to daisy chain several Model 706s for an extended number of channels and how to scan using different scanner cards.

### 2.5.4 Scanning Examples

**Example 1 Manual Scan (Step Scan)**—If it is desired to scan through the programmed channels manually the Model 706 can be programmed for the step scan mode. In the step scan mode the programmed channels can be scanned (closed for the programmed interval rate and then opened) one channel at a time. Upon the actuation of the START/STOP button a single channel will be scanned. For this example we will choose the following parameters.

1. First channel is 1.
2. Last channel is 10.
3. Interval time is 2 seconds.
4. Number of poles is 2.
5. Use the step scan mode.

Use the steps outlined in Table 2-6 to program the Model 706 for the preceding parameters. For the sake of simplicity we will use the Model 7056 general purpose scanner card for this example.

Upon the actuation of the START/STOP button in step 9, channel 1 is closed and the START/STOP LED is turned on. Channel 1 remains closed for two seconds (programmed interval rate) and then opens. The START/STOP LED turns off and the Model 706 advances to the next channel.

To scan the remaining channels, press the START/STOP button each time a channel is to be scanned. After the last programmed channel is scanned the instrument reverts to the first programmed channel and turns off the START/STOP LED. At this point the step scan sequence may be activated again by pressing the START/STOP button, if desired.

To stop the scanning sequence and reset the Model 706 to the programmed first channel simply press the RESET button.

**Example 2 Single Scan**—In the single scan mode all the programmed channels are scanned sequentially one time upon the actuation of the START/STOP button. The single scan sequence operates as follows:

1. The START/STOP LED turns on.
2. The programmed first channel is closed for the programmed interval rate and then opened.
3. The Model 706 then advances to the next channel, closes it for the programmed interval rate and then opens it.
4. This sequence is repeated up to and including the programmed last channel. At this point the Model 706 reverts to the programmed first channel and turns off the START/STOP LED.
5. The single scan sequence is now complete.

To help illustrate a single scan sequence we will choose the following parameters. For the sake of simplicity we will use the Model 7056 general purpose scanner card.

1. First channel is 5.
2. Last channel is 25.
3. Interval time is 0.5 seconds.

**Table 2-6. Step Scan Example**

Step	Action	Comments
1	Install the Model 7056 General Purpose Scanner Card into slot 1 of the Model 706.	Refer to paragraph 2.2.2.
2	Select appropriate line voltage and turn on the Model 706.	
3	Press PRGM, 6.	Selects PROGRAM 6.
4	Press 2, ENTER.	Selects the 2-pole mode, refer to paragraph 2.9 for more information about front panel programs.
5	Press 0, 0, 1, FIRST.	Programs channel 1 as the first channel.
6	Press, 0, 1, 0, LAST.	Programs channel 10 as the last channel.
7	Press INTERVAL, 0, 0, 2, 0, 0, 0, ENTER.	Programs the interval time for two seconds.
8	Press CHANNEL, RESET.	Selects the channel mode for display and reverts to the first channel.
9	Press START/STOP.	Initiates the step scan mode.

4. Number of poles is 2.
5. Use single scan mode.

Use the steps outlined in Table 2-7 to program the Model 706 for the preceding parameters.

Upon the actuation of the START/STOP button in step 10, channel 5 is closed for 0.5 seconds (programmed interval rate) and then opens. The Model 706 advances to the next channel and closes it for the programmed interval rate and then opens it.

The sequence continues up to and including the last programmed channel. At this point the Model 706 reverts to the programmed first channel and turns off the START/STOP LED. The single scan sequence is now complete.

Pressing the START/STOP button during a single scan sequence stops the scan at the presently displayed channel. The channel remains closed and turns off the START/STOP LED. To continue the scanning sequence from the presently displayed channel press the START/STOP button.

To stop the scanning sequence and reset the Model 706 to the programmed first channel (which is 5 in this example) simply press the RESET button.

**Example 3 Continuous Scan**—In the continuous scan mode the scanning sequence described in example 2 repeats continuously until at least one of the following conditions are met:

1. Power is interrupted.
2. During the sequence, the START/STOP button is pressed.

3. RESET button is pressed.
4. PRGM button is pressed.
5. DATE button is pressed.
6. TIME button is pressed.
7. CHANNEL button is pressed.

In the continuous scan mode all the programmed channels are scanned sequentially and the scan sequence is repeated continuously. The continuous scan is started by pressing the START/STOP button and it operates as follows:

1. The START/STOP LED is turned on.
2. The programmed first channel is closed for the programmed interval rate and then opened.
3. The Model 706 then advances to the next channel, closes it for the programmed interval rate and then opens it.
4. This sequence is repeated up to and including the programmed last channel. At this point the Model 706 reverts to the programmed first channel and repeats the sequence continuously.

To help illustrate a continuous scan sequence we will choose the following parameters. For the sake of simplicity we will use the Model 7056 general purpose scanner card.

1. First channel is 1.
2. Last channel is 100.
3. Interval time is 0.3 seconds.
4. Number of poles is 2.
5. Use continuous scan mode.

Use the steps outlined in Table 2-8 to program the Model 706 for the preceding parameters.

**Table 2-7. Single Scan Example**

Step	Action	Comments
1	Install the three Model 7056 scanner cards into slots 1, 2 and 3 of the Model 706.	Refer to paragraph 2.2.2.
2	Select appropriate line voltage and turn on the Model 706.	
3	Press PRGM, 6.	Selects PROGRAM 6.
4	Press 2, ENTER.	Selects the 2-pole mode. Refer to paragraph 2.9 for more information concerning front panel programs.
5	Press 0, 0, 5, FIRST.	Programs channel 5 as the first channel.
6	Press 0, 2, 5, LAST.	Programs channel 25 as the last channel.
7	Press INTERVAL, 0, 0, 0, 5, 0, 0, ENTER.	Programs the interval time for 0.5 seconds.
8	Press CHANNEL, RESET.	Turns on the CHANNEL LED, selects the channel mode for display and resets to the programmed first channel.
9	Press SINGLE.	Selects the single scan mode and turns on the SINGLE LED.
10	Press START/STOP.	Initiates the single scan sequence.

**Table 2-8. Continuous Scan Example**

Step	Action	Comments
1	Install 10 Model 7056s into slots 1-10 of the Model 706.	Refer to paragraph 2.2.2.
2	Select appropriate line voltage and turn on the Model 706.	
3	Press PRGM, 6.	Selects PROGRAM 6.
4	Press 2, ENTER.	Selects the 2-pole mode. Refer to paragraph 2.9 for more information about front panel programs.
5	Press 0, 0, 1, FIRST.	Programs channel 1 as the first channel.
6	Press 1, 0, 0, LAST.	Programs channel 100 as the last channel.
7	Press INTERVAL, 0, 0, 0, 3, 0,0, ENTER.	Programs the interval time for 0.3 seconds.
8	Press CHANNEL, RESET.	Turns on the CHANNEL LED, selects the channel mode for display and resets to the programmed first channel.
9	Press CONTINUOUS.	Selects the continuous scan mode and turns on the CONTINUOUS LED.
10	Press START/STOP.	Initiates the continuous scan sequence.

Upon the actuation of the START/STOP button in step 10, channel 1 is closed and the START/STOP LED is turned on. Channel 1 remains closed for 0.3 seconds (programmed interval rate) and then opens. Model 706 advances to the next channel and closes it for the programmed interval rate and then opens it.

This sequence continues up to and including the last programmed channel. At this point the Model 706 reverts to the programmed first channel and repeats this scan sequence continuously.

Pressing the START/STOP button during a continuous scan sequence stops the scan at the presently displayed channel. The channel remains closed and the START/STOP LED turns off. To continue the scanning sequence from the presently displayed channel press the START/STOP button.

To stop the scanning sequence and reset the Model 706 to the programmed first channel (which is 1 in this example) simply press the RESET button.

**Example 4 Daisy Chain Configuration**—In a situation where more than 100 channels are required the Model 706 can be connected to other Model 706 scanners to increase the number of available channels. A total of five Model 706 scanners can be connected together to increase the number

of available channels to 500. The method of connection is shown in Figure 2-4 and is referred to as a daisy chain configuration.

One of the Model 706 scanners is programmed (by user choice) as the master control instrument of the configuration. The other Model 706 scanners are programmed as the slaves. As slaves, the front panel controls of these instruments are locked out (not functional) except for the power switch, front panel Program 90 and 91. The power switch is functional but when power is cycled the slave instrument powers up to the slave condition. The only method out of the slave condition is to activate Program 90 or 91. For complete details concerning front panel programs refer to paragraph 2.9.

In this example the master Model 706 will be programmed to scan 500 channels. The equipment required for this example is shown in Table 2-9. For the sake of simplicity we will use Model 7056 general purpose scanner cards for this example. To help illustrate this daisy chain example we will choose the following parameters:

1. First Channel is 1.
2. Last channel is 500.
3. Interval time is 0.2 seconds.
4. Number of poles is 2.
5. Use continuous scan mode.

**Table 2-9. Required Equipment for Daisy Chain Example**

Description	Specification	Mfg.	Model	Qty
Scanner Mainframes	—	Keithley	706	5
Scanner Cards	General Purpose	Keithley	7056	50
Cables	BNC to BNC	Keithley	7051-5	5

Use the steps outlined in Table 2-10 to program the daisy chain configuration for the preceding parameters.

Upon the actuation of the START/STOP button in step 13, the continuous scan sequence starts from the programmed first channel. The continuous scan mode operates in the same manner as described in example 3. The only difference is that this example will scan 500 channels and then repeat the sequence continuously.

Pressing the START/STOP button during a continuous scan

sequence stops the scan at the presently displayed channel. The channel remains closed and the START/STOP LED turns off. To continue the scanning sequence from the presently displayed channel press the START/STOP button. The first and last channels are not battery backed up in the daisy chain configuration.

To stop the scanning sequence and reset the Model 706 to the programmed first channel (which is 1 in this example) simply press the RESET button.

**Table 2-10. Daisy Chain Example**

Step	Action	Comments
1	Install the Model 7056 scanner cards into the Model 706 mainframes.	Refer to paragraph 2.2.2.
2	Set up the circuit shown in Figure 2-4.	
3	Select appropriate line voltage and turn on the Model 706 scanners.	
4	Program 4 Model 706 scanners as a slave by pressing PRGM, 9, 2 on each 706.	Programs the Model 706 as slaves in the daisy chain configuration.
5	Select the remaining Model 706 as the master of the configuration by pressing PRGM, 9, 1.	Sets one Model 706 as the master control of the daisy chain configuration.
<p><b>NOTE</b> Initiating front panel PROGRAM 92 locks up the Model 706 front panel, except for the power button, PROGRAM 90 and 91. The following message is displayed while front panel PROGRAM 92 is activated.</p> <div style="border: 1px solid black; padding: 5px; width: fit-content; margin: 0 auto;"> <p style="font-family: monospace; font-size: 1.2em;">S L A V E</p> </div>		
6	On the master control 706 press PRGM, 6.	Selects PROGRAM 6. All programming will be done on the master control 706 from this step on.
7	Press 2, ENTER.	Selects the 2-pole mode. Refer to paragraph 2.9 for more information concerning front panel programs.
8	Press 0, 0, 1, FIRST.	Programs channel 1 as the first channel.
9	Press 5, 0, 0, LAST.	Programs channel 500 as the last channel.
10	Press INTERVAL, 0, 0, 0, 2, 0, 0, ENTER.	Programs the interval time for 0.2 seconds.
11	Press CHANNEL, RESET.	Turns on the CHANNEL LED, selects the channel mode for display and resets to the programmed first channel.
12	Press CONTINUOUS.	Selects the continuous scan mode and turns on the CONTINUOUS LED.
13	Press START/STOP.	Initiates the continuous scan mode sequence.

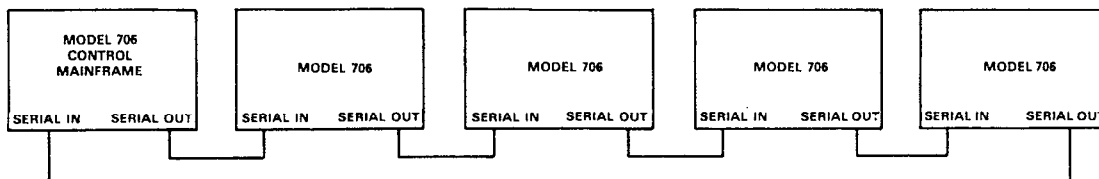

**Figure 2-4. Daisy Chain Configuration**

The display in the daisy chain configuration includes an additional digit to accommodate up to 500 channels, 1000 channels in 1-pole mode. The display is shown as follows:

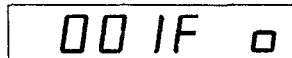

**NOTE**

Scanning at a high rate of speed in the daisy chain configuration may not show the scanned channels on the mainframe's display.

**Example 5 Temperature Scan**—With the Model 7057A thermocouple scanner card, the Model 706 can scan temperature points. Since the Model 7057A combines the functions of a thermocouple scanner and uniform temperature reference it is especially useful for scanning thermocouples. The input terminals are #10 alloy copper set in an isothermal block to minimize temperature differences. A thermistor sensor within the isothermal block is used with a bridge network located on the Model 7057A. The temperature of the heat sink is used to calculate the corrected thermocouple output. The output voltages of each thermocouple must be converted to temperature (°C or °F) using appropriate thermocouple tables or polynomial equations. These equations and tables are provided in the Model 7057A Instruction Manual.

In this example the Model 706 will be programmed to scan 25 separate temperatures. The following parameters will be programmed into the Model 706.

1. First channel is 1.
2. Last channel is 25.
3. Number of poles is 2.
4. Interval time is 3 seconds.
5. Use the continuous scan mode.

**NOTE**

Channels 1, 11 and 21 are the temperature references for the cards.

Use the steps outlined in Table 2-11 to program the Model 706 for the preceding parameters.

As you can see this temperature scan example is quite similar to the continuous scan example (example 3). The only appreciable difference is the type of scanner card used in each example. Except for specified values of the parameters selected, front panel operation is similar in all scanning sequences.

For more detailed information concerning temperature scans refer to the Model 7057A Instruction Manual.

**Example 6 Low Current Scan**—With the Model 7058 installed, the Model 706 is capable of scanning currents in the range of picoamps. The Model 7058 is a low current scanner card that is field installable in the scanner mainframe. The Model 7058 is designed to introduce a minimum of offset current (< 1pA), while guarding ensures that high isolation ( $10^{15}\Omega$ ) is maintained between input signals.

The actual measurement of the low current should be done with a high quality electrometer such as the Model 614 or Model 619. A high quality picoammeter such as the Keithley Model 480 could also be used. All three of these instruments are capable of measuring in the range of picoamps with high accuracy. To measure such low currents a number of measurement parameters such as, input impedance, cabling, measurement configuration, etc., must be taken into consideration. This example does not attempt to give instructions on low current measurement, the instruction manuals provided with each of the previously mentioned electrometers

**Table 2-11. Temperature Scan Example**

Step	Action	Comments
1	Install a Model 7057A into slots 1, 2 and 3 of the Model 706.	Refer to paragraph 2.2.2.
2	Select appropriate line voltage and turn on the Model 706.	
3	Press PRGM, 6.	Selects PROGRAM 6.
4	Press 2, ENTER.	Selects the 2-pole mode, refer to paragraph 2.9 for more information concerning front panel programs.
5	Press 0, 0, 1, FIRST.	Programs channel 1 as the first channel.
6	Press 0, 2, 5, LAST.	Programs 25 as the last channel.
7	Press INTERVAL, 0, 0, 3, 0, 0, 0, 0, ENTER.	Programs the interval time for three seconds.
8	Press CHANNEL, RESET.	Turns on the CHANNEL LED, selects the channel mode for display and resets the instrument to the first channel.
9	Press CONTINUOUS.	Turns on the CONTINUOUS LED and selects the continuous scan mode.
10	Press START/STOP.	Initiates the continuous scan mode sequence.



and picoammeter give step by step instructions on how to measure low currents accurately.

In this example, the Model 706 will be programmed to scan 37 low current sources. Also, the following parameters will be programmed into the Model 706.

1. First channel is 1.
2. Last channel is 37.
3. Interval time is 2 seconds.
4. Number of poles is 2.
5. Use single scan mode.

Use the steps outlined in Table 2-12 to program the Model 706 for the preceding parameters.

As you can see this low current scan example is similar to the other scanning examples. The only appreciable difference is

the type of scanner card used in each example. Except for the specified values of the parameters selected, front panel operation is similar in all scanning sequences.

For more detailed information concerning low current scans refer to the Model 7058 Instruction Manual.

## 2.6 FRONT PANEL CLOCK OPERATION

The CLOCK group on the front panel contains the TIME and DATE buttons. The clock continues to run after the Model 706 is turned off. This is because the clock's power circuitry is backed up by battery BT101. The time is shown in a 24 hour display format. To display the time mode simply press the TIME button. To set the time, use the steps outlined in Table 2-13.

**Table 2-12. Low Current Scan Example**

Step	Action	Comments
1	Install a Model 7058 into slots 1, 2, 3 and 4 of the Model 706.	Refer to paragraph 2.2.2.
2	Select appropriate line voltage and turn on the Model 706	
3	Press PRGM, 6.	Selects PROGRAM 6.
4	Press 2, ENTER.	Selects the 2-pole mode, refer to paragraph 2.9 for more information concerning front panel programs.
5	Press 0, 0, 1, FIRST.	Programs channel 1 as the first channel.
6	Press 0, 3, 7, LAST.	Programs channel 37 as the last channel.
7	Press INTERVAL, 0, 0, 2, 0, 0, 0, ENTER.	Programs the interval time for two seconds.
8	Press CHANNEL, RESET.	Turns on the CHANNEL LED, selects the channel mode for display and resets the instrument to the first channel.
9	Press SINGLE.	Turns on the SINGLE LED and selects the single scan mode.
10	Press START/STOP.	Initiates the single scan mode sequence.

**Table 2-13. Setting the Time**

Step	Action	Comments
1	Press TIME*.	Selects the time mode for display and turns on the TIME LED.
2	Press the DATA buttons (0-9) that correspond to the desired time. For example, to set the time for 7:30 A.M. press 0, 7, 3, 0, 0, 0, ENTER.	Set the time for 7:30 A.M.

\*Pressing the TIME button during a scan sequence stops the sequence, turns on the TIME LED and selects the time mode for display.

Upon the actuation of the ENTER button, the time is set to 7:30 A.M. As another example, set the time to 7:30 P.M. by pressing 1, 9, 3, 0, 0, 0, ENTER.

To display the DATE mode, simply press the DATE button. The date is displayed in one of two formats. The formats are the American date format and the International date format. These formats are described in paragraph 2.9.2. The formats are selected exclusively by front panel Program 1. Refer to paragraph 2-9 for complete details concerning the front panel programs. To set the date, use the steps outlined in Table 2-14.

As another example, set the date to August 18th for the international date format by pressing:

1. PRGM, 1 (Selects front panel Program 1 for display.)
2. 1, ENTER. (Selects the international date format.)
3. 1, 8, 0, 8, ENTER. (Enters 18.08 for the date August 18th.)

## 2.7 DETAILED FRONT PANEL CONTROLS DESCRIPTION

1. **POWER ON/OFF**—The On/Off switch operates on the push-push principle. Depressing this button turns the instrument on. Once the instrument is on, pressing (releasing) this button turns the instrument off. When the Model 706 is turned on it goes through a power up sequence as outlined in paragraph 2.3. When the power up sequence is complete the Model 706 displays the following:

0 1 F o

where:

- 01 = Channel Number One
- F = First Channel\*
- o = Channel Open

\*If channel 1 was previously programmed as the first channel, last channel or both, it is displayed as such. This is because the first and last functions are battery backed up and not affected by power up.

### NOTE

If upon power up the Model 706 displays the slave or no loop message (refer to paragraphs 2.9.11 and 2.9.12) activate Program 90 return the Model 706 to normal operating conditions. To activate Program 90, press PRGM 9,0.

To identify the previous state of the functions that are not affected by power up, simply activate the desired function. When the function is activated the previous state for that function is displayed. Refer to paragraph 2.5.1 for information concerning the actuation of the desired function. Refer to Table 2-2 for power up default conditions.

2. **CHANNEL**—The CHANNEL button selects the channel mode for display. The channel number is displayed on the front panel as a two digit number, except in the daisy chain or matrix mode. Upon power up the Model 706 reverts to the channel mode.

Pressing the CHANNEL button while the Model 706 is in the channel mode increments the channel number by one. Actuation of the clock, date, PRGM, single, continuous, or interval functions takes the Model 706 out of the channel mode. Actuation of the reset function during any of the front panel programs except Programs 90, 91, 92 and 99 reverts the Model 706 to the channel mode.

3. **OPERATION**—The OPERATION group consists of four function buttons: FIRST, LAST, CLOSE and OPEN. The buttons are described as follows:

**CLOSE**—Upon actuation of the close function the presently displayed channel closes. If the presently displayed channel is already closed, pressing the CLOSE button has no effect on the channel. When the presently displayed channel is open and the CLOSE button is pressed the open and close digit (furthest digit on the right of the display) changes to a c and that channel is closed. Refer to the following display.

0 1 F c

← Open and Close Digit

- o = Channel Open
- c = Channel Closed

Table 2-14. Setting the Date

Step	Action	Comments
1	Press DATE.*	Selects the date mode for display and turns on the DATE LED.
2	Press the DATA buttons (0-9) that correspond to the desired date.	For example, to set the date to August 18th for the American date format follow steps 3, 4 and 5.
3	Press PRGM, 1.	Selects front panel PROGRAM 1 for display.
4	Press 0, ENTER.	Selects the American date format.
5	Press 0, 8, 1, 8, ENTER.	Enter 08.18 for the date August 18th.

\*Pressing the DATE button during a scan sequence stops the sequence, turns on the DATE LED and selects the date mode for display.



To ensure reliable performance, do not simultaneously close more relays than the mainframe power supply can handle. The closure limit depends on factors such as the drive current of each relay, temperature, and ventilation.

Table 2-15 lists the maximum current available from the mainframe power supply for energizing relays under different operating conditions. To find the maximum number of simultaneous relay closures, divide the current listed by the specified drive current per relay. Remember that some cards energize two relays for each channel (e.g., Models 7063 and 7067).

**Table 2-15. Maximum Relay Drive Current from Mainframe**

Temp.	Bench-top (Louvers unobstructed)	Rack-mount (1" space between scanners)	Rack-mount (No space between scanners)
23° C	4.3A	4.3A	4.3A
50° C	3.3A	2.3A	1.3A

**OPEN** — Upon actuation of the open function the presently displayed channel opens. If the presently displayed channel is already open, pressing the OPEN button has no effect on the channel. When the presently displayed channel is closed and the OPEN button is pressed the open and close digit (furthest digit on the right of the display) changes to an o and that channel is opened. Refer to the following display.

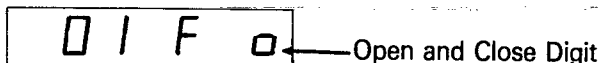

o = Channel Open  
c = Channel Closed

**NOTE**

Close and open for each channel remains valid even when not viewing the channel or the display.

**FIRST** — Upon actuation of the FIRST button the presently displayed channel is designated as the first channel of a multi-channel configuration. If the presently displayed channel has already been specified as the first channel, pressing the FIRST button has no effect on the channel or the display. If the presently displayed channel has not been designated as the first channel, the display format is as follows:

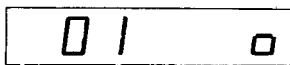

where:  
01 = Present Channel  
o = Channel Open

Pressing the FIRST button designates the channel as first channel and the display format is as follows:

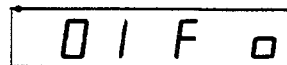

where:  
01 = Present Channel  
F = First Channel  
o = Channel Open

There are a number of ways to change the designated first channel they are listed as follows:

- A. Select the desired new channel then press FIRST.
- B. Activate Program 99.
- C. Activate Program 90.

**NOTE**

Powering the unit down will not change the designated first channel.

**LAST** — Upon actuation of the LAST button the presently displayed channel is designated as the last channel of the multi-channel configuration. If the presently displayed channel has already been specified as the last channel, pressing the LAST button has no effect on the channel or the display. If the presently displayed channel has not been designated as the last channel, the display is as follows:

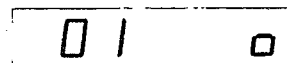

where:  
01 = Present Channel  
o = Channel Open

Pressing the LAST button designates the channel as last channel and the display format is as follows:



where:  
10 = Present Channel  
L = Last Channel  
o = Channel Open

There are two ways of changing the designated last channel they are listed as follows:



- A. Select desired new channel and press LAST.
- B. Activate Program 99.

**NOTE**

Powering the unit down will not change the designated last channel.

If the presently displayed channel is designated as the first and last channel the display format is as follows:



where:

- 10 = Present Channel
- F = First Channel
- L = Last Channel
- o = Channel Open

- 4. **CONTROL**—The CONTROL group of buttons consist of the RESET button and the INTERVAL button. The buttons and their functions are described as follows:

**RESET**—Actuation of the RESET button opens all channels of the Model 706 and reverts the display to the designated first channel. Actuating the RESET button during a single or continuous scan mode sequence stops the scan sequence, opens all channels and reverts the display to the designated first channel. The RESET button is inactive in the time, date, interval and Programs 8, 90, 91, 92 and 99.

**INTERVAL**—The INTERVAL button selects the programmed interval time for display. The interval time is the programmed time each channel is closed when using the step, single or continuous scan mode. The interval time ranges from 000.010 seconds to 999.999 seconds. Upon the actuation of front panel Program 99 the interval time is reverted to the default condition of 000.010. Powering the unit down will not change the programmed interval time. There are two ways the interval time can be changed and they are as follows:

- A. Activate Program 99 (resets to 000.010).
- B. Press the INTERVAL button and then press the appropriate number from 000.010 to 999.999. Press ENTER.

- 5. **DATA**—The DATA group of buttons consist of the 0-9, CANCEL and ENTER buttons. They are described as follows:

**0-9**—The 0-9 data keys allow entry of numerical data onto the display. The 0-9 keys can be used to enter numerical constants on the display for certain functions such as interval time, channel number, front panel programs, time and date.

**ENTER**—Upon actuation, the ENTER button loads the displayed data for channel number, interval time, time, date and program modes into the Model 706. In the program mode, the ENTER button initiates the selected program (0-7) after the necessary data is entered onto the display.

**CANCEL**—During the entry of data (C segment cursor is flashing) the CANCEL button cancels the present display and reverts the instrument to the previous display. The CANCEL button is functional only when entering data onto the display in the channel, interval, time, date and program modes.

Refer to Table 2-16 for an example of the CANCEL button function.

In Table 2-16 the interval display mode is selected and a 120 second interval time is entered onto the display. For some reason or other the interval time in step 2 is an error so the CANCEL button was pressed to revert the display to the previously programmed interval time.

- 6. **SCAN**—The SCAN group of buttons consists of SINGLE, CONTINUOUS, and START/STOP buttons. These three buttons select the different scan modes and are described as follows:

**CONTINUOUS**—Actuation of the CONTINUOUS button selects the continuous scan mode and turns on the continuous LED. The continuous scan mode allows the user to scan through the programmed channels at the programmed interval rate, continuously. The continuous scan mode is initiated upon the actuation of the START/STOP button or upon receiving the appropriate external trigger pulse.

Pressing the START/STOP button during a continuous scan sequence stops the scan at the presently displayed channel. To continue the scan sequence simply press the START/STOP button.

**Table 2-16. CANCEL Function Example**

Step	Action	Comments
1	Press INTERVAL.	Selects interval display mode and turns on the INTERVAL LED.
2	Press 1, 2, 0, 0, 0, 0.	Enters 120 second interval time on the display.
3	Press CANCEL.	Reverts the interval time data of step 2 to the previously programmed interval time.

**SINGLE**—Actuation of the SINGLE button selects the single scan mode and turns on the single LED. The single scan mode allows the user to scan through the programmed channels at the programmed interval rate, one time.

The single scan mode is initiated upon the actuation of the START/STOP button or upon receiving the appropriate external trigger pulse.

Pressing the START/STOP button during a single scan sequence stops the scan at the presently displayed channel. To continue the scan sequence simply press the START/STOP button.

**START/STOP**—The START/STOP button is an alternate action control that has three functions. The three functions are the start function, stop function and the step scan mode. These functions are described as follows:

- A. **START**—The start function of the START/STOP button initiates the selected scan mode. When all the parameters (interval time, first and last channels, scan mode, etc.) of a multi-channel configuration have been programmed and the user is ready to scan the channels, press the START/STOP button to initiate the scan sequence. During the scan sequence the START/STOP LED is activated.
- B. **STOP**—The stop function of the START/STOP button stops the previously initiated scan sequence. That is, pressing the START/STOP button during a scan sequence stops the sequence at the presently displayed channel and turns off the START/STOP LED. The STOP function is active only during a scan sequence.
- C. **STEP**—The step scan mode allows the user to manually step through the programmed channels. The step scan mode is selected by pressing the channel button, programming the interval rate and pressing the START/STOP button. When the interval rate has been programmed and the user is ready to manually scan the channels, press the START/STOP button to scan one channel.

Upon initiating the step scan mode the START/STOP LED turns on, the presently displayed channel is closed for the programmed interval rate, the channel is then opened and the START/STOP LED turns off. At this point the Model 706 advances to the next channel and then stops.

To scan the next channel press the START/STOP button and the Model 706 repeats the same sequence with the presently displayed channel.

7. **CLOCK**—The CLOCK group of buttons consist of the TIME and DATE buttons. The clock (time and date) continues to run after the instrument is powered down because the clock circuitry is backed up by battery BT101. The two buttons are described as follows:

**TIME**—The TIME button selects for display the 24 hour time clock. The format showing 2:45 pm is as follows:

1445.00

The time can be set by pressing the TIME button, entering the appropriate time onto the display and then pressing the ENTER button. Note that the time 28:00:00 to 33:59:59 can be entered. It is invalid but it can be entered.

**DATE**—The DATE button selects the date mode for display. The date display has two formats. The formats showing June 17th are as follows:

American Date Format 06.17

International Date Format 17.06

The formats are selected by front panel Program 1. Refer to paragraph 2-9 for more information concerning front panel programs. The date can be set by pressing the DATE button, entering the appropriate date onto the display and then pressing ENTER. Refer to paragraph 2.6.

8. **PRGM**—The PRGM button when pressed shows a display that prompts the user to select one of the 15 front panel programs. Refer to paragraph 2.9 for complete details and examples of the front panel programs.
9. **IEEE Indicators**—The IEEE bus indicators (TALK, LISTEN and REMOTE) identify the present status of the IEEE-488 bus. The indicators are described as follows:

**TALK**—The TALK LED when lit indicates that the Model 706 is in the talk mode. The Model 706 does not have to be in the remote mode for it to be in the talk mode.

**LISTEN**—The LISTEN LED when lit indicates that the Model 706 is in the listen mode. The Model 706 must also be in the remote mode for it to be in the listen mode.

**REMOTE**—The REMOTE LED when lit indicates that the Model 706 is in the remote mode.

## 2.8 DETAILED REAR PANEL DESCRIPTION

1. **CARD SLOTS**—Each card slot on the Model 706 rear panel can accommodate one scanner card. There are a total of 10 card slots. That is, the Model 706 can accommodate 10 scanner cards. The Model 706 with 10 scanner cards has up to 100 2-pole channels. Refer to paragraph 2.2.2 for instructions on how to remove or install the various scanner cards.
2. **EXT. TRIGGER**—The external trigger is a BNC connector that initiates the selected scan mode (single, step or continuous) in the same manner as the START/STOP button. The input trigger pulse must be a negative going TTL level pulse with a minimum duration of 2 $\mu$ sec. The selected scan mode is initiated upon the negative transition of the pulse.

This feature can be used to trigger the Model 706 into the selected mode using another instrument.

3. **CHANNEL READY**—The CHANNEL READY output is a BNC output connector that provides a negative going TTL level pulse with a duration of greater than 10 $\mu$ sec at the completion of the programmed settling time. This feature can be used to inform another instrument (DMM, Source, etc.) that the present channel settling time is completed.
4. **ALARM/SERIAL IN**—The ALARM/SERIAL IN connector has two functions. The alarm out function and the serial in function. They are described as follows:

**ALARM**—The alarm function outputs a negative going TTL level pulse with a duration of greater than 10 $\mu$ sec. This pulse appears once upon reaching the programmed alarm time. The alarm time can be programmed by front panel Program 7. When the alarm time is set to 00.00.00 the pulse does not appear. The programmed alarm time is set to 00.00.00 when power to the instrument has been cycled. Refer to Table 2-3.

**SERIAL IN**—The serial in function is used in a daisy chain configuration where the ALARM/SERIAL IN connector is connected to the SERIAL OUT connector of another Model 706. Refer to example 4 of paragraph 2.5.4.

5. **SER. OUT**—The SER. OUT connector is a BNC output connector that provides a connection to another Model 706 for a daisy chain configuration. The SERIAL OUT connector is applied to the ALARM/SERIAL IN connector of another Model 706. Refer to example 4 of paragraph 2.5.4.
6. **DIGITAL I/O**—The DIGITAL I/O port consists of 16 digital input and output lines along with four lines that are +5V and IEEE common. Eight of the I/O lines can be used for inputs and eight can be used for outputs. The outputs will drive one TTL load and the inputs are TTL compatible. For more information concerning the digital I/O port refer to paragraph 3.5.8 step 15.
7. **IEEE-488 INTERFACE**—The IEEE bus connector provides bus connection to the Model 706. The connector mates with the Keithley Model 7008-3 and 7008-6 cables. For more detailed information concerning the IEEE connector refer to paragraph 3.3.
8. **LINE FUSE**—This is the line power fuse and it is rated as specified in Table 5-2.
9. **LINE RECEPTACLE**—The line power receptacle mates with a three wire line cord which provides connections to line voltage. For correct line voltage selection refer to paragraph 5.3.

## 2.9 FRONT PANEL PROGRAMS

This section contains instructions necessary for operating the

15 internal programs of the Model 706. The programs are activated by pressing the PRGM button along with the button representing the appropriate program number. The programs do a number of various tasks which are summarized in Table 2-17.

### Program Notes

1. Each program is entered by pressing the PRGM button followed by the desired program number.
2. Pressing the PRGM button selects the program mode and the following is displayed:



As you have noticed, the question mark is flashing. This is prompting the operator to enter the desired program number (refer to Table 2-17). After entering the program number the Model 706 goes into the program selected. Then the display prompts the operator to enter numerical data. Numerical data varies with each program.

3. New programs may be entered without clearing a program that is presently running. To do so, press the PRGM button followed by the desired program number.
4. Data is entered into the digit whose "C" segment (cursor) is flashing by pressing the desired number button. The "C" segment of a display is shown as follows:

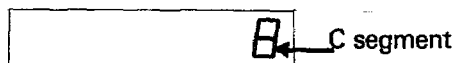

As each digit is entered, the cursor moves one place to the right until the last digit on the right is reached. Then it is cycled to the first digit on the left.

5. Only as many significant digits as necessary need to be entered. The Model 706 will complete the constants with trailing zeroes where necessary.
6. Invalid keys will be ignored. If an invalid key is pressed the blinking "C" segment (cursor) remains at the current digit.
7. If an incorrect digit is entered, the complete constant must be re-entered. The new value may be entered by cycling the display around to the beginning. To do this, repeatedly press one of the number buttons.
8. If too many digits are entered, the display begins again at the first digit on the left. All the digits in the constant must then be entered again. This applies only to Programs 0, 2, 3, 6 and 7.
9. Once all the digits of the desired constants are shown on the display, the constant is entered into the program by pressing the ENTER button. This applies only to Programs 0 through 7.

**Table 2-17. Summary of Front Panel Programs**

Program	Operation
0*	Digital I/O (Input/Output) Port
1	American/International Date Format
2	Relay Settle Time
3	Set IEEE Primary Address
4	Save Relay Set Up
5	Recall Relay Set Up
6	Pole Configuration (0, 1, 2 or 4)
7*	Alarm Time Set
8*	Diagnostic Self Test
90	Stand Alone
91	Master
92	Slave
93*	Inspect Mode
94	Clear
99*	Reset

\*Denotes NOT battery backed up.

**2.9.1 Program 0 Digital I/O**

Program 0 allows the user to control the outputs on the digital I/O port. The I/O port is located on the rear panel of the Model 706. The output code is displayed in base eight (octal) on the front panel. The actual I/O port output data is in 8 bit form. The range of octal output data that can be entered on the front panel display is 0 to 377. The maximum octal data is 377 which corresponds to 11111111 in BCD. If the front panel data is entered as 377 then the digital I/O output data is 11111111. To initiate Program 0 use the following procedure:

1. Press PRGM and the following is displayed:



2. Press 0 and the following is displayed for approximately 0.5 seconds:

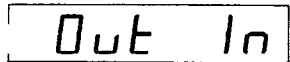

After the Out/In message is displayed, the Model 706 displays the following:

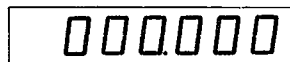

Where the first three digits represent the digital output (in octal) and the last three digits represent the digital inputs (in octal).

**NOTE**

The digital I/O inputs are defined by the connections on the input pins. With no connections on the input pins (located on the rear panel) the inputs are undefined. The digital I/O outputs are programmed by using Program 0.

3. Press 0, 7, 7, ENTER. This action programs the output bits on the digital I/O port for 00111111.

**2.9.2 Program 1 Date Format**

Program 1 is used to select one of two date formats. The two formats are the american date format and the international date format. The display format is as follows:

American: mm.dd  
International: dd.mm

where: mm = month  
dd = day

To enable Program 1 and select the international date format, use the following procedure:

1. Press PRGM. Selects program mode and displays Pro ?.

**NOTE**

The flashing question mark on the display prompts the user for the decimal program number.

2. Press 1. This action selects Program 1 and displays the following:

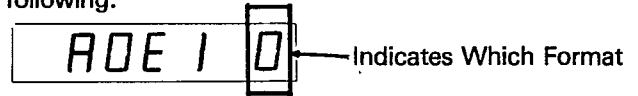

where:

AOE1 = American or International  
0 = American Date Format  
1 = International Date Format

Notice that the last digit's "C" segment is flashing. This prompts the user to enter the appropriate data.

3. Press 1. This action selects the international date format.
4. Press ENTER. This action displays the data in the international date format and turns on the DATE LED.

To enable program 1 and select the american date format use the following procedure:

1. Press PRGM. Selects program mode, displays Pro ? and turns off the DATE LED.
2. Press 1. Select Program 1 and the following is displayed:



3. Press 0. This selects the american date format and turns on the DATE LED.
4. Press ENTER. This displays the date in the american date format and turns on the DATE LED.

**NOTE**

The date format is battery backed up. Shutting off the power to the unit does not affect the date format. It will remain as programmed until it is reprogrammed.

The date, as well as the time, continues to run even when power to the instrument is shut off. The reason for this is that the clock's power circuitry is backed up by battery BT101.

Setting or changing the date is as simple as selecting the date format. For example, use the following procedure to set the date in american date format for November 24.

1. Press PRGM. Selects program mode and displays Pro ?.
2. Press 1. Selects Program 1, turns off the DATE LED and displays the following:

AOE 1 0

3. Press ENTER. The american date format was selected in the previous procedure. Pressing ENTER displays the date in the american date format and turns on the DATE LED.
4. Press 1, 1, 2, 4, ENTER. This action programs the date for November 24 and displays the following:

1 1 2 4

### 2.9.3 Program 2 Relay Settle Time

Program 2 is used to program the amount of time (000.005sec to 999.999sec) the relays and all the measurement equipment connected to a particular channel has to settle out. Do not confuse the settle time with the interval time. The interval time is the selected time a relay is closed in a scanning sequence. The interval time overrides the settle time. That is, if the settle time is set to two seconds and the interval time is set to one second the scan sequence will operate at one second interval rate.

Therefore, the settle time must always be shorter in duration than the interval time.

At the end of the programmed settle time the Model 706 outputs a negative going, TTL level pulse with a duration of greater than 10µsec. This pulse appears at the CHANNEL READY output. The CHANNEL READY output is BNC connector located at the rear panel of the Model 706. The purpose of the settle time program is to have a selectable settle time for all instruments connected to a particular channel. Then the pulse that appears at the CHANNEL READY output can be used to inform another instrument (e.g. DMM, printer or even the Model 706) that the settle time is complete.

To initiate Program 2 use the following procedure:

1. Press PRGM. This selects the program mode and displays Pro ?.
2. Press 2. Selects Program 2 and displays the following for approximately 0.5 seconds.

SEETLE

After the settle message is displayed, the Model 706 displays:

000005

This display is shown in seconds. The minimum settle time is 000.005 seconds and the maximum settle time is 999.999 seconds. The settle time is not affected by power up. This is because the circuitry is backed up by battery BT101.

Programming the settle time is a simple procedure. For example, use the following procedure to program the settle time to 001.010 seconds.

1. Press PRGM. Selects the program mode and displays Pro ?.
2. Press 2. Selects Program 2 and displays the settle message described in step 2 of the previous procedure. Then the previously programmed settle time is displayed.
3. Press 0, 0, 1, 0, 1, 0, ENTER. This step loads 1.01 seconds as the settle time on the display. Pressing ENTER programs 1.01 seconds as the settle time and the Model 706 reverts to the channel mode at the previously displayed channel.

#### NOTE

Initiating a new interval time resets the settle time counter. If the settle time is greater than the interval time the CHANNEL READY output pulse does not appear upon the completion of a scanning sequence.

### 2.9.4 Program 3 Set IEEE Primary Address

Program 3 is used to set the primary address of the Model 706 for IEEE-488 bus operation. The primary address of the Model 706 is factory set to 18, but it may be set to any value between 0 and 31 via front panel Program 3. This is a convenient feature that eliminates the cumbersome rear panel switches that are generally used in other instruments to set primary address.

The primary address specified in the controller's programming language must agree with the primary address of the Model 706. Front panel Program 3 is the only way to change the Model 706's primary address.

#### NOTE

If other instrumentation is connected to the bus, be sure that each device has a different primary address. If the precaution is not observed, erratic operations may result.

To initiate Program 3 and change the primary address to 22 use the following procedure:

1. Press PRGM. Selects the program mode and displays Pro ?.
2. Press 3. Selects Program 3 and displays the following:

IE 18



where:

IE = IEEE Indicator

18 = Primary Address

3. Press 2, 2, ENTER. This step loads the number 22 onto the display. Pressing the ENTER button programs the primary address to 22 and reverts the Model 706 to the channel mode at the previously displayed channel.
4. Press PRGM, 3. This step shows the user that the primary address has indeed changed to 22.
5. Now that you know how, change the primary address back to 18.

### 2.9.5 Program 4 Save Relay Set Up

Program 4 is used to save (store) the present relay set up for future use. This program is capable of storing 75 separate relay set ups. This means the user can program 75 different relay set ups, store the set ups, then use the stored set ups when the need arises without reprogramming.

Program 4 is very useful in a situation where the instrument and/or experiment is going to be shut down for a period of time and the user does not want to reprogram the relay set up when power is returned to the unit. The program is also helpful when the user has programmed one relay set up and needs to go to another completely different set up without destroying or losing the existing set up. In this case it's possible to program one relay set up and store it with Program 4, then program a different set up and store it with Program 4. This way the user has both relay set ups stored for further use.

#### NOTE

The Model 706 can only use one relay set up at a time, they cannot be used simultaneously.

As an example of using Program 4, program the Model 706 for 10 channels with the odd numbered channels closed and the even numbered channels open. When the set up is complete, save the set up by using Program 4. Use the following procedures to implement this example:

1. Press RESET. Selects the channel mode and reverts the instrument to the programmed first channel.
2. Press 0, 0, 1, FIRST. Selects channel 1 as the first channel.
3. Press 0, 1, 0, LAST, Selects channel 10 as the last channel.
4. Press RESET. Reverts to the programmed first channel.
5. Press CLOSE. Closes presently displayed channel.
6. Press CHANNEL, CHANNEL, CLOSE. Advances the Model 706 to channel 3 and closes it.
7. Press CHANNEL, CHANNEL, CLOSE. Advances the Model 706 to channel 5 and closes it.
8. Press CHANNEL, CHANNEL, CLOSE. Advances the Model 706 to channel 7 and closes it.
9. Press CHANNEL, CHANNEL, CLOSE. Advances the

Model 706 to channel 9 and closes it.

10. Press PRGM, 4. Selects program mode, selects Program 4 and displays the following:



11. Press 1, ENTER. Select the relay set up 1 to be stored and when ENTER is pressed the set up is stored in location SAVO1. The display is then reverted to the channel mode at the previously displayed channel.

To verify that the relay set up has been stored use the following procedure:

1. Press RESET. Reset to the programmed first channel and opens all relays.
2. Press PRGM, 5. Selects program mode and also Program 5.
3. Press 0, 1, ENTER. Selects location 01 and recalls the set up.
4. Press CHANNEL nine times and notice that the odd numbered channels are all closed and the even numbered channels are all open. This verifies that relay set up was indeed stored using Program 4.

For another test of the relay set up, shut off power to the Model 706 for a few minutes. Turn the instrument back on and press PRGM, 5, 0, 1, ENTER. Notice that the odd channels are closed and the even channels are open. Thus, even when power to the instrument was shut off the relay set up remained in memory.

To store an additional relay set up, program the set up and press PRGM, 4, 0, 2, ENTER. This action saves the relay set up without disturbing the previously stored set up. This can be done with up to 75 separate set ups.

The factory set values of Program 4 are all channels open and channel 1 is the programmed first and last channel.

#### NOTE

Program 4 saves the entire relay set up programmed on the Model 706. It does not save just the relay set up between the programmed first and last channels. Program 4 also works in the matrix mode.

### 2.9.6 Program 5 Recall Relay Set Up

Program 5 is used to recall a previously stored relay set up. Program 4 and 5 work in conjunction with each other. Program 4 is used to store a relay set up while Program 5 is used to recall the relay set up that was stored using Program 4. Program 5 also recalls the programmed first and last channels along with the relay set up that was stored in the example of Program 4.

In the example of Program 4, 10 channels were selected with the odd channels closed and the even channels open. The set

up was stored and then the Model 706 was reset by using the RESET button. This is the point where we will start the example of Program 5. To recall the stored relay set up, use the following procedure:

1. Press RESET. Reverts instrument to programmed first channel and opens all channels.
2. Press PRGM, 5. Selects program mode and also Program 5. After the 5 button is pressed the Model 706 displays the following:

r E C 0 1

This display indicates that the recall program has been activated. The display prompts the user for the specific relay set up that is stored (1 through 75).

3. Press 0, 1, ENTER. Selects relay set up number 1 to be recalled and when ENTER is pressed the set up is recalled.

After ENTER is pressed, the Model 706 recalls relay set up number 1 and displays the channel that was shown previous to pressing PRGM. In this case, the following is displayed because step 1 reset the display to the programmed first channel.

0 1 F c

In order to verify that the stored set up was recalled proceed to step 4.

4. Press CHANNEL nine times and notice that the odd numbered channels are closed and the even numbered channels are open. This shows that the stored relay set up was indeed recalled by Program 5.

The factory set values of Program 5 are all channels open and the programmed first and last channels are set to 1. Program 5 also works in the matrix mode, refer to paragraph 2.9.13 for an example.

In the matrix mode of operation pressing the START/STOP button displays the Recall display along with the present memory location. Pressing the START/STOP button in the matrix mode and while the recall display is shown, advances the instrument to the next memory location. Pressing the CHANNEL button while the recall display is shown, selects the channel display mode. By repeatedly pressing the CHANNEL button the crosspoints of that memory location are displayed. If in the inspect mode, all the closed crosspoints can be displayed (one at a time, not simultaneously). Refer to paragraph 2.9.13 for inspect mode information.

Pressing the START/STOP button repeatedly to advance through the stored memory locations is an easy way to locate a desired memory location. This procedure will go through all the stored locations up to location 75 or to where a memory location has been cleared (Program 94) or to the last stored memory location and then loop back to memory location 01. If memory location 01 was cleared using Program 94, attempting to recall the location is not valid and cannot be recalled. This is true for all the locations.

## 2.9.7 Program 6 Pole Configuration

Program 6 is used to program the desired number of measurement poles or to select the matrix mode.

**Measurement Poles**—The Model 706 permits either 1, 2 or 4-pole measurements. Table 2-18 contains a list of the different scanner cards and which pole configuration to use with each scanner card.

**Table 2-18. Scanner Card Pole Configuration**

Scanner Card	Pole Configuration to Use
7052	0 pole (Matrix)
7053	2 and 4 pole
7054	2 pole
7056	1, 2 or 4 pole
7057A	2 pole
7058	2 pole
7059	2 pole or 4 pole

The 1-pole configuration can be used by operators who need to switch just one (HI) side of their configuration. The 2-pole configuration can be used for normal measurements. The 4-pole configuration can be used for 4-terminal ohms or a switched HI, LO COM and Guard measurement. The matrix mode (0-pole on the Model 706) can be used to switch any one point to another.

The pole configuration is displayed by activating Program 6. The pole configuration can be changed by activating Program 6 and pressing the desired number (0, 1, 2 or 4). For example, use the following procedure to change the present pole configuration to 4.

1. Press PRGM, 6. Selects Program 6 and displays the following:

POLE 2

### NOTE

Upon the actuation of front panel Program 99, the Model 706 sets the pole configuration to 2. Power up does not affect the pole configuration.

2. Press 4, ENTER. Loads 4 onto the display and when ENTER is pressed, the pole configuration is set to 4. The Model 706 then reverts to the channel mode, turns on the channel LED and displays the programmed first channel.

### NOTE

Before pressing the ENTER button in step 2, the Model 706 ignores the entry of any invalid number (3, 5, 6, 7, 8, 9) for this program.

To verify that the pole configuration was changed to 4, press Program 6, and the display shows that it was changed to 4. Now change the pole configuration to 2. This can be done by

activating front panel Program 99 or by using the following procedure:

1. Press PRGM, 6.
2. Press 2, ENTER.

In the 1-pole mode the display is slightly different as shown in the following display.

00 1F o

The additional display digit is due to the fact that up to 200 channels may be realized in the 1-pole mode. This only works with the Model 7056 general purpose scanner card.

**Matrix Mode**—Using the Model 7052 matrix scanner card with the Model 706 requires that the matrix mode be activated. The matrix mode precludes the use of the continuous or single scan modes. The matrix mode can only be used in the step scan mode. To activate the matrix mode use the following procedure:

1. Press PRGM, 6. Selects program mode and Program 6.
2. Press 0, ENTER. Selects matrix mode.

After the ENTER button in step 2 is pressed, the Model 706 is placed in the matrix mode and the following is displayed:

00 1 1o

where the format is as follows:

nnn m O or C

where:

nnn = Three digit number displaying the column. Where there can be a total of five columns per card, 10 cards per 706, five daisy chained 706's maximum. This can be a maximum of 250 columns.

m = The row from 1 to 4.

o or c = The crosspoint is either opened or closed.

The matrix mode displays crosspoints instead of channels. Crosspoints consists of the junction of one row with one column. On each Model 7052 matrix card there are five columns and four rows. Refer to Figure 2-5.

**Example 1**—For an example of a matrix crosspoint display consider the following:

004 3c

where:

004 Denotes the #1 (001 through 050 denotes unit #1).

004 Also, denotes card #1 of unit #1 (001 through 005 denotes card #1 of unit #1).

004 Also, denotes column #4 of card #1 of unit #1 (001 through 005 denotes the columns of card #1 of unit #1).

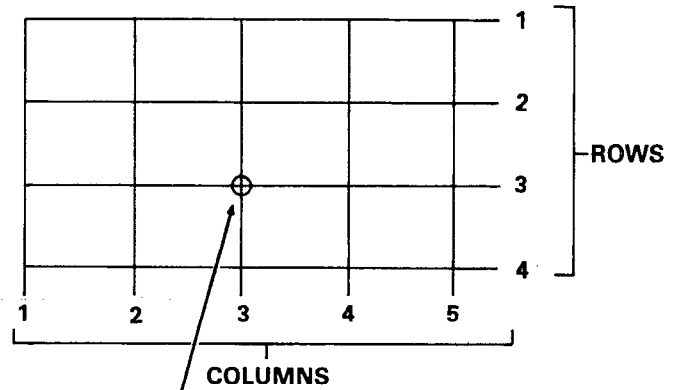

**A TYPICAL CROSSPOINT ON THE MODEL 7052 MATRIX CARD CONSISTS OF A 3-POLE FORM A RELAY AS SHOWN.**

**Figure 2-5. Model 7052 Matrix Scheme**

3 Denotes row #3.

c Denotes the crosspoint is closed.

Therefore, the display 004 3 c means that the crosspoint of unit #1, card #1, column #4, row #3 is closed.

**Example 2**—For another example, consider a 4 x 50 matrix which would be 10 Model 7052 matrix cards with jumpers installed between the rows of each card. A matrix display could be as follows:

048 4c

where:

048 Denotes unit #1 (001 through 050 denotes unit #1).

048 Also, denotes card #10 of unit #1 (046 through 050 denotes card #10 of unit #1).

048 Also, denotes column #3 of card #10 of unit #1 (046 through 050 denotes columns of card #10 of unit #1).

4 Denotes row #4.

c Denotes the crosspoint is closed.

Therefore, the display 048 4c in a matrix means that the crosspoint of unit #1, card #10, column #3, row #4 is closed.

**Example 3**—As another example, consider a 40 x 5 matrix which would be 10 Model 7052 matrix cards with jumpers installed between the columns of each card. A matrix display could be as follows:

043 2o

where:

043 Denotes unit #1 (001 through 050 denotes unit #1).

043 Also, denotes card #9 of unit #1 (041 through 045 denotes card #9 of unit #1).

043 Also, denotes column #3 of card #9 of unit #1 (041 through 045 denotes columns of card #9 of unit #1).

2 Denotes row #2.

o Denotes crosspoint is open.

Therefore, the display 043 2o means that in a 40 × 5 matrix set up the crosspoint of unit #1, card #9, column #3, row #2 is open.

Refer to Figure 2-6, Table 2-19 and Table 2-20 for further clarification of the matrix mode display.

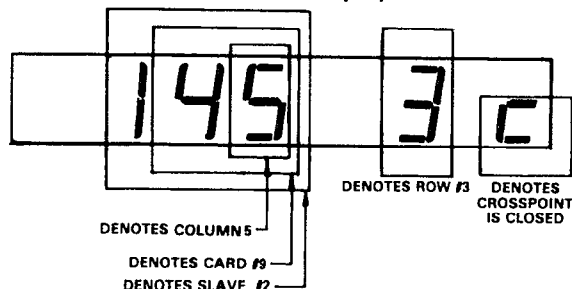

Figure 2-6. Matrix Display Clarification

Table 2-19. Matrix Unit Number Display Assignment

Unit Number	Display Assignment
Master	001 through 050
Slave #1	051 through 100
Slave #2	101 through 150
Slave #3	151 through 200
Slave #4	201 through 250

**1-Pole Mode**—The 1-Pole mode is available on the Model 7056 scanner card. On the card, relay K111 is the output relay for the even channels and relay K112 is the output relay for the odd channels. These relays close when the appropriate channel relays close. In the 1-pole mode, each channel relay on the Model 7056 scanner card controls two channels. This is because each relay is a 2-pole relay. For example, if the channel 1 relay is closed, then the channel 2 relay is also closed because they are the same relay. The closed channels do not reach the output unless the appropriate output relay is closed.

In some situations this may close channels that are not programmed as closed. For example, if channel 1 and 4 are programmed as closed, then because of the scanner card's architecture channels 2 and 3 are also closed. Refer to the following chart.

Table 2-20. Matrix Card Number Display Assignment

Card #	Display Assignment				
	Master	Slave #1	Slave #2	Slave #3	Slave#4
1	001-005	051-055	101-105	151-155	201-205
2	006-010	056-060	106-110	156-160	206-210
3	011-015	061-065	111-115	161-165	211-215
4	016-020	066-070	116-120	166-170	216-220
5	021-025	071-075	121-125	171-175	221-225
6	026-030	076-080	126-130	176-180	226-230
7	031-035	081-085	131-135	181-185	231-235
8	036-040	086-090	136-140	186-190	236-240
9	041-045	091-095	141-145	191-195	241-245
10	046-050	096-100	146-150	196-200	246-250

**1-Pole**

**Nomenclature**

- Channel 1 = Channel 1 Relay + Output Relay K112
- Channel 2 = Channel 1 Relay + Output Relay K111
- Channel 3 = Channel 2 Relay + Output Relay K112
- Channel 4 = Channel 2 Relay + Output Relay K111
- Channel 5 = Channel 3 Relay + Output Relay K112
- Channel 6 = Channel 3 Relay + Output Relay K111
- Channel 7 = Channel 4 Relay + Output Relay K112
- Channel 8 = Channel 4 Relay + Output Relay K111

**2-Pole**

**Nomenclature**

- Channel 19 = Channel 10 Relay + Output Relay K112
- Channel 20 = Channel 10 Relay + Output Relay K111

**2.9.8 Program 7 Set Alarm Time**

Program 7 is used to set the alarm time. The alarm time is the preprogrammed time that the Model 706 outputs a negative going TTL level pulse with a duration of greater than 10µsec at the ALARM/SERIAL IN connector. The ALARM/SERIAL IN connector is located on the rear panel of the Model 706. The alarm pulse can be used to inform another instrument to start a measurement sequence. The external instrument (e.g. controller, DMM, printer, etc.) can then start on its own function in the measurement system. The alarm time is displayed as a 24 hour clock format. The display format is as follows:

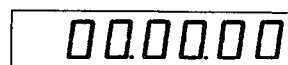

For an example of setting the alarm time, use the following procedure to program the alarm time for 2:45 pm.

1. Press PRGM, 7. Selects Program 7 and displays the following message for approximately 0.5 seconds.



After the alarm message is displayed, the 24 hour clock format is displayed. If the alarm time was not previously programmed the alarm time is set to all zeroes. When the time is set to 00.00.00 no output pulse will appear on the ALARM/SERIAL IN connector.

2. Press 1, 4, 4, 5, 0, 0, ENTER. Loads 14.45.00 onto the display and when ENTER is pressed the alarm time is set to 2:45 pm. The Model 706 then reverts to the channel mode which turns on the CHANNEL LED and shows the previously displayed channel.

### NOTE

The alarm time is now set to 2:45 pm. The alarm pulse will appear at the ALARM/SERIAL IN connector everyday at 2:45 pm until it is reprogrammed, power is shut off or front panel Program 99 is activated.

To verify that the alarm time was set to 2:45 pm by the preceding example, press PRGM, 7. This action selects Program 7 and displays the previously stored alarm time. Upon power up or upon activating front panel Program 99, the Model 706 sets the alarm time to 00.00.00. When the alarm time is set for 00.00.00, no output pulse appears at the ALARM/SERIAL IN connector.

### 2.9.9 Program 8 Diagnostic Self Test

Program 8 is used to run a test on the ROM, RAM circuitry and also to test the front panel LEDs. This test is also performed in the power up sequence. If it is desired to run the test without shutting power off to the unit, Program 8 can be used. For example, if the user needs to run the self test but does not want to reset the alarm time (alarm time is not battery backed up) then Program 8 can be used. This way the alarm time is not reset and the Model 706 RAM, ROM and front panel LEDs are tested. Use the following procedure to activate Program 8.

1. Press PRGM. Selects program mode.
2. Press 8. Initiates the Program 8 test sequence.

Once step 2 is completed the Model 706 performs the following sequence:

First, the Model 706 turns on all the segments in the display and also turns on the CHANNEL, INTERVAL, CONTINUOUS, SINGLE, START/STOP, TIME, DATE, TALK, LISTEN and REMOTE LEDs. The turned on display segments are shown as follows:

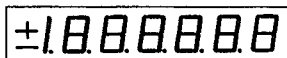

This is a display test. The operator can note inoperative display segments by comparing the Model 706 display with the preceding figure. In addition, the push button and the TALK, LISTEN and REMOTE LEDs turn on. All LEDs are turned on simultaneously if operating correctly. While all the LEDs are on, the Model 706 is performing a cyclic redundancy check (CRC) of the ROM circuitry. A digital self test of the RAM circuitry is also performed at this time. If the digital self test reveals a problem with the RAM circuitry the Model 706 displays the following for approximately 0.5 seconds.

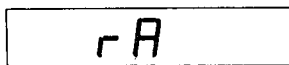

After this display the Model 706 displays the following:

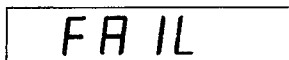

If the CRC reveals a problem with the ROM circuitry the Model 706 displays the following for approximately 0.5 seconds:



After this display the Model 706 displays the following:

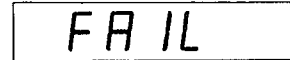

If the self test and the CRC both reveal a problem, the Model 706 displays the RAM and ROM error messages and then displays the fail message.

When either test does not reveal a problem the Model 706 displays the following message which indicates that both tests have passed:

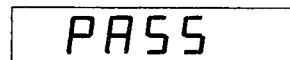

After the pass message the Model 706 reverts to the previously shown display. For example, if the Model 706 was set to 01 F o then that is the display it will revert to after the pass message.

### 2.9.10 Program 90 Stand Alone

Program 90 is used to program a Model 706 out of the master and slave programs (Programs 91 and 92 respectively) into normal front panel operation. Once Program 90 is activated the Model 706 operates as a stand alone instrument. This means that even if it is connected in a daisy chain configuration the Model 706 will not be the master control or a slave in the configuration. To activate Program 90 use the following procedure:

1. Press PRGM. Selects program mode.
2. Press 9, 0. After pressing the 0 button the Model 706 displays the following two messages and reverts to the channel mode. The CHANNEL LED turns on, the programmed first and last channels are set to 1 and channel 1 is displayed.

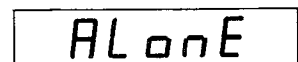

### NOTE

After actuating program 90 cycle power to the instrument or activate Program 99 in order to set the ALARM/SERIAL IN connector to alarm output.

### 2.9.11 Program 91 Master

Program 91 is used to set the Model 706 as the master control of a daisy chain configuration. The designated master Model 706 is the only unit in a daisy chain configuration that has front panel control. All operation in a daisy chain configuration is controlled from the master Model 706.

If the Model 706 is not connected in a daisy chain configuration, or the other daisy chained Model 706 scanners are not

programmed as slaves, activating Program 91 produces the following two messages:

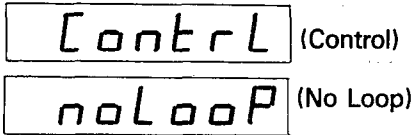

The Model 706 will remain in the no loop display condition until all other daisy chained Model 706s are connected and programmed as slaves or any front panel program other than 91 is activated.

To activate Program 91 use the following procedure:

1. Connect the Model 706 to at least one other Model 706 in a daisy chain configuration. See Figure 2-4.
2. Install the appropriate scanner cards.
3. Turn the units on.
4. Select all but one Model 706 as the slave(s) of the configuration.
5. Press PRGM, 9, 2 of the selected slave unit(s).
6. Press PRGM, 9, 1 of the selected master Model 706.

The following message is displayed upon pressing 1.



After the control display, the Model 706 reverts to the channel mode and displays the programmed first channel. At this point the Model 706 is programmed as the master control of the daisy chain configuration. To program the Model 706 for a relay configuration, refer to paragraph 2.5.3. The only difference is the extended number of channels provided by the daisy chain configuration.

To program the master Model 706 out of the master condition activate Program 90.

### 2.9.12 Program 92 Slave

Program 92 is used to set the Model 706 as a slave unit in a daisy chain configuration. The slave unit(s) respond to the commands of the designated master control unit in the configuration. The slave unit or units do not have any control in the set up, except power on/off, Programs 90 and 91. The slave unit's primary function is to increase the number of channels in a daisy chain configuration.

To activate Program 92 use the following procedure:

1. Connect the Model 706 to at least one other Model 706 in a daisy chain configuration. See Figure 2-4.
2. Install the appropriate scanner cards.
3. Turn the units on.
4. Select a unit(s) as the slave(s).

#### NOTE

Select any Model 706 to be a slave in the daisy

chain configuration except the Model 706 that is designated as the master.

5. Press PRGM, 9, 2 of the selected slave unit(s). The following message is displayed upon pressing the number 2.



The display message remains on the display as long as the unit is programmed as a slave unit. To program the Model 706 out of the slave configuration condition one of the following actions can be used.

1. Activate front panel Program 90.
2. Activate front panel Program 91.

### 2.9.13 Program 93 Inspect Mode

Program 93 is used to examine a relay set up. Examination of a relay set up means that the closed channels of the set up are displayed but not closed. While in the inspect mode pressing the CHANNEL button advances the display to the next closed channel, or if in the matrix mode, the next closed crosspoint. In the inspect mode, only the closed channels or crosspoints are displayed.

#### NOTE

In the inspect mode the relays are not closed, they are just examined.

Program 93 is a convenient feature that allows the user to examine the closed channels of a relay set up. If Program 93 is not used and the user needs to examine the relay set up, the user must go through all the programmed channels or crosspoints. With Program 93 activated the user can display the closed channels or crosspoints of the set up. To activate and then deactivate Program 93 use the following procedure:

1. Press PRGM, 9, 3. This step activates the inspect mode. The inspect mode can be activated regardless (except slave mode) of what mode the Model 706 was in. Note, on the Model 706 display, that the middle decimal point is blinking. This signifies that the inspect mode has been activated. The following is displayed for approximately 0.5 seconds and then reverts to previous display.

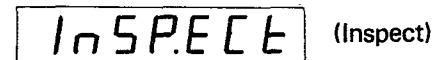

2. Press PRGM, 9, 3. While the inspect mode is activated pressing PRGM, 9, 3, takes the Model 706 out of the inspect mode. The following is displayed for approximately 0.5 seconds and then reverts to the previous display.

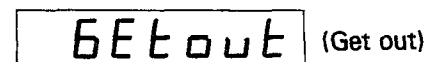

Program 93 acts as a toggle. When the Model 706 is not in the inspect mode pressing PRGM, 9, 3, activates the inspect mode. While the Model 706 is in the inspect mode pressing PRGM, 9, 3, takes the Model 706 out of the inspect mode.

Using Program 4 and 5 in conjunction with Program 93 allows the user to store, recall and inspect up to 75 different relay set

ups. The following example will program, store, recall and inspect three different relay set ups all of which are in the matrix mode. Programs 4, 5 and 93 will be used throughout the example.

1. Press RESET. Reset the Model 706.
2. Press PRGM, 9, 3. Activates the inspect mode and displays the following for approximately 0.5sec.

INSPECT

After the inspect display, the Model 706 reverts to the previously displayed channel or crosspoint with the blinking decimal point.

3. Press PRGM, 6, 0, ENTER. Activates matrix mode.
4. Press 0, 0, 1, 1, CLOSE. Closes crosspoint 001 1 c.
5. Press 0, 0, 2, 2, CLOSE. Closes crosspoint 002 2 c.
6. Press 0, 0, 3, 3, CLOSE. Closes crosspoint 003 3 c.
7. Press PRGM, 4, 0, 1, ENTER. Stores the present relay set up in location 01.
8. Press RESET. Resets Model 706.
9. Press 0, 0, 1, 2, CLOSE. Closes crosspoint 001 2 c.
10. Press 0, 0, 2, 3, CLOSE. Closes crosspoint 002 3 c.
11. Press 0, 0, 3, 4, CLOSE. Closes crosspoint 003 4 c.
12. Press PRGM, 4, 0, 2, ENTER. Stores the present relay set up in location 02.
13. Press RESET. Resets the Model 706.
14. Press 0, 0, 1, 3, CLOSE. Closes crosspoint 001 3 c.
15. Press 0, 0, 2, 4, CLOSE. Closes crosspoint 002 4 c.
16. Press 0, 0, 3, 1, CLOSE. Closes crosspoint 003 1 c.
17. Press PRGM, 4, 0, 3, ENTER. Stores the present relay set up in location 03.
18. Press RESET. Resets the Model 706.
19. Press PRGM, 5, 0, 1, ENTER. Recalls relay set up 01.
20. Press CHANNEL, CHANNEL, CHANNEL. Pressing the CHANNEL button while in the inspect mode advances the display to the next closed crosspoint. When the last closed crosspoint of a set up is reached pressing CHANNEL displays the first closed crosspoint of the set up.
21. Press RESET. Resets Model 706.
22. Press PRGM, 5, 0, 2, ENTER. Recalls relay set up 02.
23. Press CHANNEL, CHANNEL, CHANNEL, CHANNEL. Displays all the closed crosspoints of relay setup 02. Then displays first closed crosspoint.
24. Press RESET. Resets Model 706.
25. Press PRGM, 5, 0, 3, ENTER. Recalls relay set up 03.
26. Press CHANNEL, CHANNEL, CHANNEL, CHANNEL. Advanced to and displays all the closed crosspoints of relay set up 03. Then loops back to the first closed crosspoint.
27. Press PRGM, 9, 3. Takes the Model 706 out of the inspect mode and displays get out for ½ sec.

(Get Out)

GET OUT

28. Press CHANNEL, CHANNEL, CHANNEL. This step shows that when the Model 706 is out of the inspect mode, pressing CHANNEL advances the display to the next channel whether it is open or closed. While in the inspect mode pressing CHANNEL advances the display to the next closed crosspoint.

#### NOTE

Program 93 may also be used in the normal mode (out of matrix). In the normal mode the closed channels are displayed.

#### NOTE

In the inspect mode, pressing CHANNEL advances and displays the next closed channel or crosspoint. The crosspoint or channel is NOT CLOSED, it is just displayed for the user's inspection.

The preceding example has shown how to:

1. Activate Program 93 inspect mode (step 2).
2. Activate matrix mode (step 3).
3. Program three relay set ups and store them using Program 4. (steps 4-17).
4. Recall the stored relay set ups (steps 19, 22 and 25).
5. Inspect the closed crosspoints of the set up (steps 20, 23 and 26).
6. Take the Model 706 out of the inspect mode (step 27).

#### NOTE

Activating Program 99 or shutting off power to the Model 706 takes the instrument out of the inspect mode.

#### 2.9.14 Program 94 Clear

Program 94 is used to clear a buffer location. A buffer location consists of a relay set up that was stored using Program 4. Up to 75 relay set ups can be stored and individually cleared of data using Program 94. Use the following example to:

- Store five relay set ups in location 1 thru 5.
- Clear locations 3, 4 and 5 using Program 94.

1. Press PRGM, 4, 0, 1, ENTER. Selects Program 4 and stores the present relay set up in location 01. For simplicity in this procedure the relay set up is all relays open.
2. Press PRGM, 4, 0, 2, ENTER. Selects Program 4 and stores the present relay set up in location 02. For simplicity in this procedure the relay set up is all relays open.
3. Press PRGM, 4, 0, 3, ENTER. Selects Program 4 and stores the present relay set up in location 03. For simplicity in this procedure the relay set up is all relays open.
4. Press PRGM, 4, 0, 4, ENTER. Selects Program 4 and stores the present relay set up in location 04. For simplicity in this procedure the relay set up is all relays open.

5. Press PRGM, 4, 0, 5, ENTER. Selects Program 4 and stores the present relay set up in location 05. For simplicity in this procedure the relay set up is all relays open.
6. Press PRGM, 9, 4. Selects Program 94 and displays the following message.

CLr 05

This display informs the user that the clear program is activated and is presently at memory location 05.

7. Press ENTER. Clears memory location 05 and returns to the previously shown channel display.
8. Press PRGM, 9, 4. Selects Program 94.
9. Press 0, 4, ENTER. Clears memory location 04 and returns to the previously shown channel display.
10. Press PRGM, 9, 4. Selects Program 94.
11. Press 0, 3, ENTER. Clears memory location 03 and returns to the previously shown channel display.

After completing step 11 memory locations 3, 4 and 5 are cleared. To verify that the locations have been cleared, activate Program 5 for locations 3, 4 and 5. Use the following procedure to illustrate this.

1. Press PRGM, 5. Selects Program 5 recall.
2. Press 0, 5. Sets the instrument to recall memory location 05 and displays the following:

rEC 05

3. Press ENTER. This step attempts to recall memory location 05. But when ENTER is pressed the instrument reverts to the following display because memory location 5 has been cleared.

rEC 01

4. Repeat steps 1, 2 and 3 for memory locations 3 and 4. This will verify that the location have indeed been cleared.

#### NOTE

Program 94 is different from storing all relays open in a memory location. Using Program 94 to clear a memory location wipes out the location altogether. Attempting to recall a cleared memory location is not valid. The memory location (if it is needed) will have to be programmed using Program 4.

In the matrix mode, steps 1 thru 4 could be used differently. After step 4 the user would press ENTER. This will display the recall message. Now press START/STOP to advance through the stored memory locations. In this example set ups 03, 04 and 05 are cleared. Therefore, pressing the START/STOP button a few times shows that only set ups 01 and 02 exist. There could be more locations beyond location 05, but using this method of the START/STOP button while in the matrix mode, stops at the location where there is no location and loops back to location 01.

To clear all the buffer locations press PRGM, 4, 0, 0.

#### 2.9.15 Program 99 Reset

Program 99 is used to reset the Model 706 to the conditions listed in Table 2-21. To activate Program 99 use the following procedure:

1. Press PRGM. Selects program mode.
2. Press 9, 9. Initiates front panel Program 99.

Upon completion of step 2 the Model 706 goes through a reset sequence that is described as follows:

1. Upon completion of step 2 the Model 706 responds by displaying the following message:

rESET

2. After the reset message, all front panel LEDs turn on for a period of time as shown in the following display.

±10.000000

The push button and TALK, LISTEN and REMOTE LEDs also turn on at this time. During this time the Model 706 performs a cyclic redundancy check (CRC) of the ROM circuitry and a digital self test of the RAM circuitry. Refer to Program 8 for details on the ROM and RAM checks.

3. After all the front panels are turned on and then off, the Model 706 displays the current software revision level for approximately 0.5 seconds. The following display is an example of software revision level A1.

A1

4. After the software revision level is displayed the Model 706 displays the primary address for approximately 0.5 seconds. The following display is an example of primary address 18.

1E 18

Once the primary address display is shown the Model 706 is in the Program 99 reset condition as defined by Table 2-21.



**Table 2-21. Program 99 Reset Conditions**

Function or Program	Reset Condition
CHANNEL	All channels are open and the display is set to* 
TIME	Time is not affected by PROGRAM 99.
DATE	Date is not affected by PROGRAM 99.
RESET	Reset is not affected by PROGRAM 99.
INTERVAL	Interval rate is set to 000.010.
CONTINUOUS	Continuous scan mode is set to inactive.
SINGLE	Single scan mode is set to inactive.
START/STOP	Start/stop function is set to stop.
Program 0	Digital I/O outputs are set to 000, the inputs are not affected by PROGRAM 99.
Program 1	Date is set to American date format.
Program 2	Settle time is set to 000.005 seconds.
Program 3	Primary address is set to 18.
Program 4	Save relay set up is cleared.
Program 5	Recall relay set up is cleared.
Program 6	Pole configuration is set to 2.
Program 7	Alarm time is set to 00.00.00.
Program 8	Self test is not affected by PROGRAM 99.
Program 90	PROGRAM 90 is performed.
Program 91	PROGRAM 91 is not performed.
Program 92	PROGRAM 92 is not performed.
Program 93	PROGRAM 93 is disabled by PROGRAM 99.
Program 94	PROGRAM 94 is set to inactive.
Program 99	PROGRAM 99 is used to reset the Model 706.
FIRST	Programmed first channel is set to 1.
LAST	Programmed last channel is set to highest available channel.

\* When the Model 706 is in the slave mode (PROGRAM 92), activating PROGRAM 99 has no effect.

## SECTION 3 IEEE BUS OPERATION

### 3.1 INTRODUCTION

This section contains information necessary to operate the Model 706 over the IEEE-488 bus. The Model 706 has a standard IEEE-488 interface that allows the user to give commands and read data via an external device. All front panel programs and functions are available over the bus (except Programs 3, 90, 91 and 92).

A typical bus set up for controlled operation is shown in Figure 3-1. Generally, a system will contain one controller and a number of other instruments to which the commands are given. Device operation is categorized into three operators: controller, talker and listener. The controller does what its name implies; it controls the instruments on the bus. The talker sends data while a listener receives data. Depending on the type of instrument, any particular device can be a talker only, a listener only or both a talker and a listener.

Any given system can have only one active controller, but any number of talkers or listeners may be presented up to the hardware limitations of the bus. Generally, the bus is limited to 15 devices, but this number may be reduced if higher than normal data transfer rates are required or if longer than normal cables are used.

Only one device on the bus may be a talker at any given time while several devices can be commanded to listen. Before a device can talk or listen it must be appropriately addressed. Devices are selected by their primary address. Usually, each device on the bus has its own primary address so that each device may be addressed individually. The primary address of the Model 706 is factory set at 18. The factory set primary address may be changed via front panel Program 3. For more information concerning front panel programs refer to paragraph 2.9.

Once a device is addressed to talk or listen, the appropriate bus transactions take place. For example, if the Model 706 is addressed to talk, it places the data string on the bus one byte at a time. The controller reads the information and the appropriate software can be used to direct the information to the desired location.

#### 3.1.1 Software Consideration

The most sophisticated computer in the world would be useless without the necessary software. This basic requirement is also true of the IEEE-488 bus, which requires the use of handler routines as described in this section.

Before a controller can be used with the IEEE-488 interface the user must make certain that appropriate handler software

is present within the controller. With the HP-85 computer, for example, the HP-85 interface card must be used with an additional I/O ROM, which contains the necessary handler software.

Other small computers that can be used as controllers have limited IEEE command capability. The PET/CBM computers, for example, are incapable of sending multiline commands from BASIC, although these commands can be sent through machine language routines. The capabilities of other small computers depends on the particular interface being used. Often, little software "tricks" are required to achieve the desired results.

From the preceding discussion, the message is clear, make sure the proper software is being used with the interface. Often, the user may incorrectly suspect that a hardware problem is causing fault, when it was the software that was causing the problem all along.

#### 3.1.2 HP-85 BASIC Statements

Many of the programming instructions covered in Section 3 use examples written in Hewlett-Packard Model 85 BASIC. The HP-85 was chosen for these examples because it has a large number of BASIC statements that control IEEE-488 operation. This section covers those HP-85 BASIC statements that are essential to Model 706 operation.

A complete list of HP-85 BASIC statements is shown in Table 3-1. All the statements in the table have one or three digit arguments that must be specified. The first digit is the HP-85 interface select code, which is set to 7 at the factory. The last two digits of those statements that require a three digit argument specify the primary address. Generally, only those commands that actually require an address to be sent over the bus require that the primary address be specified in the BASIC statement.

Those statements in the table with three digit arguments assume that the primary address of the device is set at 18. Other primary addresses require that the last two digits be set to the corresponding value. For example, to send a GTL command to device 22, the following BASIC statement would be used:

LOCAL 722

Some of the statements in the table have two forms; the exact configuration used depends on the desired command. For example, CLEAR 7 will cause a DCL to be sent while CLEAR 718 causes a SDC to be transmitted to device 718.

The third column of Table 3-1 lists the mnemonics for the command sequences. While most of these are covered elsewhere, a few points should be noted. The ATN line is set low by the controller if the data bus contains a multiline command. This is indicated in the table by ANDing the ATN mnemonic with the first command on the bus. For example, ATN•GET means that ATN and GET are sent simultaneously.

Two commands not previously covered are MLA (My Listen Address) and MTA (My Talk Address). These are ordinary PCG (Primary Command Group) addresses sent by the HP-85 to facilitate bus operation in some situations. The Model 706 will essentially ignore these commands (the Model 706 triggers on MTA in the T0 and T1 modes), but other devices may require that MLA and MTA be present in the command sequence under certain circumstances.

**NOTE**

The HP-85 address is set to 21 at the factory. Since each device on the bus must have a unique primary address, do not set the Model 706 to the controller's address to avoid possible conflicts.

**3.1.3 Interface Function Codes**

The interface function codes are part of the IEEE-488-1978 standards. These codes define an instrument's ability to support various functions and should not be confused with programming commands found elsewhere in this manual.

Table 3-2 lists the codes for the Model 706. These codes are also listed for convenience on the rear panel of the instrument near the IEEE connector. The numeric value following each one or two letter code defines the Model 706 capabilities as follows:

1. SH (Source Handshake Function)—The ability for the Model 706 to initiate the transfer of message/data on the data bus is provided by the SH function.
2. AH (Acceptor Handshake Function)—The ability for the Model 706 to guarantee proper reception of message/data on the data bus is provided by the AH function.
3. T (Talker Function)—The ability for the Model 706 to send device-dependent data over the bus (to other devices) is provided by the T function. Model 706 talker capabilities exist only after it has been addressed to talk.
4. L (Listener Function)—The ability for the Model 706 to receive device-dependent data over the bus (from other devices) is provided by the L function. Listener function capabilities of the Model 706 exist only after it has been addressed to listen.
5. SR (Service Request Function)—The ability for the Model 706 to request service from the controller is provided by the SR function.
6. RL (Remote-Local Function)—The ability for the Model 706 to be placed in the remote or local mode is provided by the RL function.
7. PP (Parallel Poll Function)—The Model 706 does not have parallel polling capabilities.
8. DC (Device Clear Function)—The ability for the Model 706 to be cleared (initialized) is provided by the DC function.
9. DT (Device Trigger Function)—The ability for the Model 706 to have its basic operation is provided by the DT function.
10. C (Controller Function)—The Model 706 does not have controller capabilities.
11. TE (Extended Talker Capabilities)—The Model 706 does not have extended talker capabilities.

**Table 3-1. HP-85 IEEE-488 BASIC Statements**

Statement	Action	Bus Command Sequence
ABORTIO 7 CLEAR 7 CLEAR 718 ENTER 718;A\$	Send IFC. Send DCL. Send SDC to device 18. Device 18 addressed to talk. Data placed is A\$.	IFC ATN•DCL ATN•UNL;MTA;LAG;SDC ATN•UNL;MLA;TAG;ATN;data
LOCAL 7 LOCAL 718 LOCAL LOCKOUT 7 OUTPUT 718;A\$	Set REN False Send GTL to device 18. Send LLO. Device 18 addressed to listen. Transmit A\$.	$\overline{\text{REN}}$ ATN•UNL;MTA;LAG;GTL ATN•LLO ATN•MTA;UNL;LAG; $\overline{\text{ATN}}$ ;data
REMOTE 7 REMOTE 718	Set REN true. Set REN true. Address device 18 to listen.	REN REN;ATN•UNL;MTA;LAG
RESET 7 SPOLL (718)	Send IFC, cancel REN. Address device 18 to talk. Conduct serial poll.	IFC;REN; $\overline{\text{REN}}$ ATN•UNL;MLA;TAG;SPE; $\overline{\text{ATN}}$ ; status byte;ATN•SPD;UNT
TRIGGER 7 TRIGGER 718	Send GET without addressing. Address device 18 to listen. Send GET.	ATN•GET ATN•UNL;MTA;LAG;GET

12. LE (Extended Listener Capabilities)—The Model 706 does not have extended listener capabilities.

**Table 3-2. Model 706 Interface Function Codes**

Code	Interface Function
SH1	Source Handshake Capability
AH1	Acceptor Handshake Capability
T6	Talker (Basic Talker, Serial Poll, Unaddressed To Talk On LAG)
L4	Listener (Basic Listener, Unaddressed To Listen On TAG)
SR1	Service Request Capability
RL1	Remote/Local Capability
PP0	No Parallel Poll Capability
DC1	Device Clear Capability
DT1	Device Trigger Capability
C0	No Controller Capability
E1	Open Collector Bus Drivers
TE0	No Extended Talker Capabilities
LE0	No Extended Listener Capabilities

**3.1.4 Model 706 Interface Commands**

Interface commands controlling Model 706 operation are listed in Table 3-3. Not included in the table are device-dependent commands, which are covered in detail in paragraph 3.5.

**Table 3-3. IEEE Command Groups**

<b>HANDSHAKE COMMAND GROUP</b>	
DAC = DATA ACCEPTED	
RFD = READY FOR DATA	
DAV = DATA VALID	
<b>UNIVERSAL COMMAND GROUP</b>	
ATN = ATTENTION	
DCL = DEVICE CLEAR	
IFC = INTERFACE CLEAR	
LLO = LOCAL LOCKOUT	
REN = REMOTE ENABLE	
SPD = SERIAL POLL DISABLE	
SPE = SERIAL POLL ENABLE	
<b>ADDRESS COMMAND GROUP</b>	
<b>LISTEN:</b>	LAG = LISTEN ADDRESS GROUP
	MLA = MY LISTEN ADDRESS
	UNL = UNLISTEN
<b>TALK:</b>	TAG = TALK ADDRESS GROUP
	MTA = MY TALK ADDRESS
	UNT = UNTALK
	OTA = OTHER TALK ADDRESS
<b>ADDRESSED COMMAND GROUP</b>	
ACG = ADDRESSED COMMAND GROUP	
GET = GROUP EXECUTE TRIGGER	
GTL = GO TO LOCAL	
SDC = SELECTIVE DEVICE CLEAR	
<b>STATUS COMMAND GROUP</b>	
RQS = REQUEST SERVICE	
SRQ = SERIAL POLL REQUEST	
STB = STATUS BYTE	
END = EOI	

**3.2 IEEE-488 BUS LINES**

As shown in Figure 3-1, the signal lines on the IEEE-488 bus are divided into three groups; management, handshake, and data lines. The management and handshake lines ensure that proper data transfer and bus operation takes place while the data lines handle the bus information. Each of the bus lines are low (true).

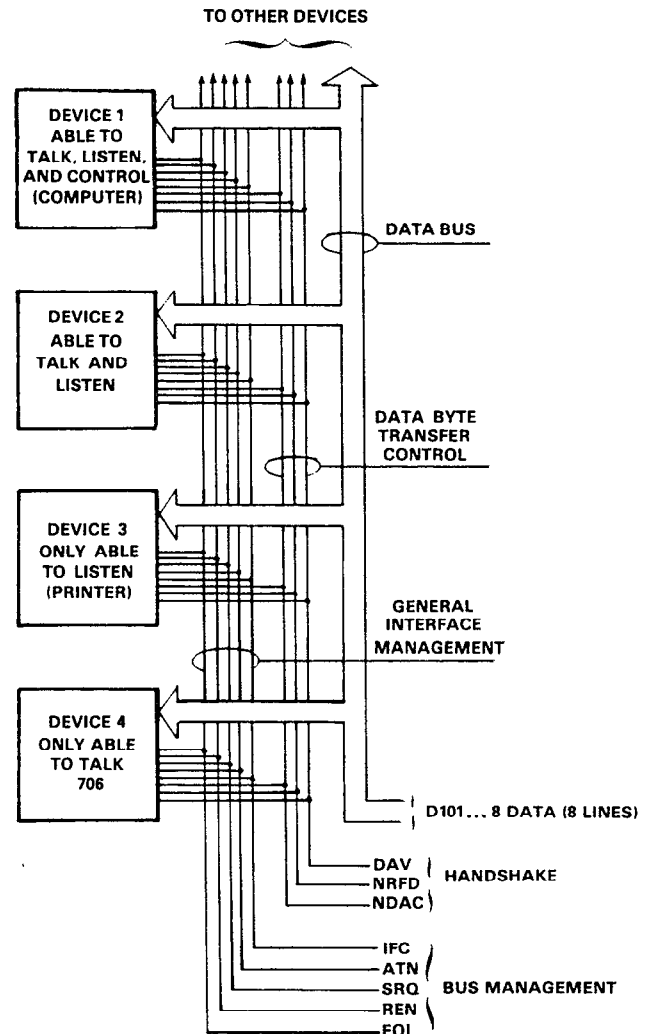

**Figure 3-1. Bus Structure**

**3.2.1 Bus Management Lines**

The bus management group consists of five signal lines that send certain single line bus commands and ensure an orderly transfer of data. The five signal lines are:

1. **ATN (Attention)**—The state of the ATN line determines whether information placed in the data bus by the controller is to be considered data or a command.
2. **REN (Remote Enable)**—Setting the REN line low (true) sends the REN command and sets up the instrument on the bus for remote operation. If REN is followed by the primary address of the Model 706, then it will be the only instrument to be placed in the remote mode.

**REN Programming Example**—The REN line is set low (true) by the HP-85 when the following line is entered into the HP-85.

REMOTE 718 (END LINE)

When the END LINE key is pressed the Model 706 is placed in the remote and the front panel REMOTE LED is turned on.

3. IFC (Interface Clear)—The IFC command is sent by the controller to set the Model 706 to the talk and listen idle states. The instrument responds to the IFC command by turning off the front panel TALK or LISTEN LEDs if the instrument was previously in one of those modes. To send the IFC command, the controller only has to set the IFC line true.

**IFC Programming Example**—Before demonstrating the IFC command, turn on the front panel REMOTE and TALK LEDs by entering the following statements into the HP-85.

REMOTE 718 (END LINE)  
ENTER 718;A\$ (END LINE)

The front panel TALK and REMOTE LEDs should now be on. The IFC command may now be sent by entering the following statement into the HP-85.

ABORTIO 7 (END LINE)  
CLEAR 7 (END LINE)

After the END LINE key is pressed, the TALK LED turns off, indicating the Model 706 is in the talk idle state. Note that the remote mode is not cancelled.

4. EOI (End Or Identify)—The EOI command is used to identify the last byte of a multi-byte transfer sequence.
5. SRQ (Service Request)—The SRQ line is set low (true) by a device when it requires service. SRQ can be identified by reading the status word.

### 3.2.2 Handshake Lines

The handshake group consists of three handshake lines which operate in an interlocked sequence. The interlocked sequence ensures reliable data transfer regardless of the transfer sequence. The slowest device on the bus usually determines the rate of transfer.

The three handshake lines are:

1. DAV (Date Valid)
2. NRFD (Not Ready For Data)
3. NDAC (Not Data Accepted)

The DAV line is controlled by the source. The NRFD and NDAC lines are controlled by the accepting devices. The

complete handshake sequence is shown in Figure 3-2. This sequence handles information one byte at a time.

Once the data is on the bus, the source checks to see that NRFD is high. At the same time NDAC should be low from the previous byte transfer. Once the NRFD and NDAC lines are properly set, the source sets the DAV line low. The NRFD line goes low; the NDAC line then goes high once all the devices on the bus have accepted the data. Each device releases the NDAC line at its own rate, but the NDAC line will not go high until the slowest device on the bus has accepted the data.

After the NDAC line goes high, the source sets the DAV line high indicating that the data is no longer valid. At this point, the NDAC line goes low. The NRFD line is released by each device on the bus but does not go high until the slowest device on the bus has released the line. The bus is now set to repeat the sequence with the next data byte.

The sequence just described is used to transfer both data and multi-line commands. The state of the ATN lines determines whether the data bus contains data or commands.

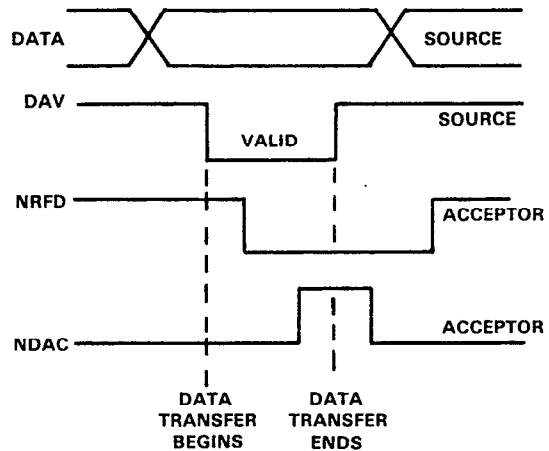

Figure 3-2. Handshake Sequence

### 3.2.3 Data Lines

The IEEE-488 bus uses eight data lines that transfer data one byte at a time. DI01 (Data Input/Output 1) through DI08 (Data Input/Output 8) are the eight data lines used to transmit both data and multiline commands, and are bi-directional. The data lines operate with low true logic.

## 3.3 SYSTEM SET UP PROCEDURE

There are two primary set up steps that prepare the system for operation. The two steps are as follows:

1. Bus Connections—The Model 706 is connected to the bus via the rear panel connector. It is a standard IEEE bus connector. Maximum cable length for any device on the bus is 20 meters. The Keithley Models 7008-3 and 7008-6

are ideal for connecting instruments to the bus. Figure 3-3 and 3-4 show the connector pin assignments and the IEEE bus connector. The connector contact designation are listed in Table 3-4.

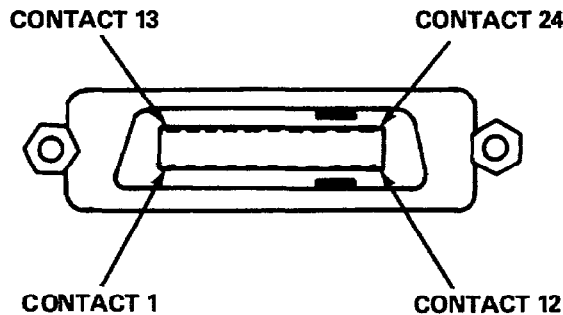

Figure 3-3. Contact Assignments

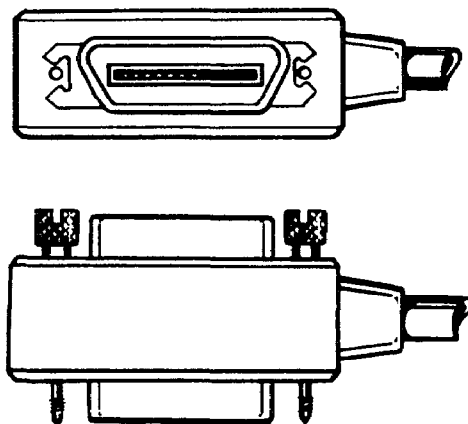

Figure 3-4. Typical Bus Connector

2. Primary Address Selection—The primary address must be set to the appropriate value when using the Model 706 in the addressable mode. The primary address is selected by front panel Program 3. For more information concerning the primary address selection refer to paragraph 2.9.4.

### 3.4 BUS COMMANDS

The Model 706 may be given a number of special bus commands through the IEEE-488 interface. This section briefly describes the purpose of the bus commands which are grouped into the following three categories:

1. Uniline Commands: Sent by setting the associated bus lines low.
2. Multiline Commands: General commands are sent with the ATN line low.
3. Device-Dependent Commands: Special commands that depend on device configurations; sent with ATN high.

Table 3-4. IEEE Bus Connector Contact Assignments

Contact Number	IEEE-488 Designation	Type
1	DIO1	Data
2	DIO2	Data
3	DIO3	Data
4	DIO4	Data
5	EOI (24)*	Management
6	DAV	Handshake
7	NRFD	Handshake
8	NDAC	Handshake
9	IFC	Management
10	SRQ	Management
11	ATN	Management
12	SHIELD**	Ground
13	DIO5	Data
14	DIO6	Data
15	DIO7	Data
16	DIO8	Data
17	REN (24)*	Management
18	Gnd, (6)*	Ground
19	Gnd, (7)*	Ground
20	Gnd, (8)*	Ground
21	Gnd, (9)*	Ground
22	Gnd, (10)*	Ground
23	Gnd, (11)*	Ground
24	Gnd, LOGIC	Ground

\*Numbers in parentheses refer to signal ground return of referenced contact number. EOI and REN signal lines return on contact 24.

\*\*The cable shield is normally connected to ground only at the controller end to avoid ground loop problems.

#### 3.4.1 Uniline Commands

As stated previously, uniline commands are sent by setting the associated bus line low (true). The five uniline (single line) commands are:

1. ATN (Attention)—The ATN commands are sent when the information on the data bus is a universal or addressed command. Universal and addressed commands are described in paragraphs 3.4.2 and 3.4.4. When the ATN line is high, the byte on the data bus is considered to be data. The Model 706 responds to the appropriate universal and addressed commands when the ATN line is low and to the device-dependent commands when the ATN line is high, assuming it is properly addressed.
2. REN (Remote Enable)—The controller sends this command to all devices on the bus when remote operation is desired. The Model 706 responds by setting itself up for remote operation as indicated by the front panel REMOTE LED.
3. EOI (End Or Identify)—EOI is sent during the last byte of a multiline transfer by setting the EOI line low. In this way,

the last byte is identified allowing variable length data words to be transmitted. The Model 706 implements this command when in the appropriate bus response mode as stated in paragraph 3.5.4.

4. IFC (Interface Clear)—The IFC command sets the bus to a known state by setting the IFC line low (true).
5. SRQ (Service Request)—The SRQ line is pulled low (true) by an external device thereby informing the controller the device requires service. The Model 706 implements this command in the appropriate bus response mode as stated in paragraph 3.5.5.

### 3.4.2 Universal Commands

The IEEE-488 universal commands are sent when the ATN line is low (true). There are six universal commands and their effect on the Model 706 operation is described as follows:

1. DCL (Device Clear)—The DCL command is used to clear the Model 706, thereby setting it to a known state. Program memory is cleared of all previously stored data when a DCL or SDC command is received. The buffer is set to location one.

**DCL Programming Example**—Using front panel controls close channels 1 through 5 on the Model 706 and select the continuous program mode. Now enter the following statements into the HP-85:

REMOTE 718 (END LINE)  
CLEAR 7 (END LINE)

When the END LINE key is pressed after CLEAR 7, the Model 706 reverts to the power up default conditions which are listed in Table 3-5. This means that all five channels that were closed are now open and the instrument is in the step program mode. For the state of the other Model 706 parameters refer to Table 3-5.

2. LLO (Local Lockout)—The LLO command is sent by the controller to remove the Model 706 from the local operating mode. Once the instrument receives the LLO command all the front panel controls (except POWER ON/OFF) are locked out. The REN bus line must be low (true) before the instrument responds to a LLO command.

**LLO Programming Example**—This sequence is automatically performed by the HP-85 when the following statements are entered into the keyboard:

REMOTE 718 (END LINE)  
LOCAL LOCKOUT 7 (END LINE)

When the END LINE key is pressed after the LOCAL LOCKOUT 7 command, the front panel controls are inactive. Press several of the buttons and notice that they have no ef-

**Table 3-5. Power Up, DCL and SDC Default Conditions**

Mode	Value	Status
Poles	A2	2-pole Configuration
Display Channel	B001	Display channel 1.
Close Channel	C000	Close channel disabled.
Display Mode	D0	Channel mode displayed.
Date Format	E0	American date format.
First Channel	F1	Set first channel, not affected.
Prefix	G000	Channel data transmitted with prefix.
Settle Time	H00.005	Settle Time = 000.005 seconds.
Store	I	Store is not affected.
Debug Test	J1	Run debug test.
(ROM, RAM and LED test)		
EOI (End or Identify)	K0	EOI is transmitted during last byte.
Set Last Channel	L1	Set last channel, not affected.
SRQ	M000	No SRQ
Open Channel	N1	Channel 1 is open.
I/O Port	O000	All I/O outputs are set low.
Program Mode	P0	Step program mode.
Alarm Time	Q00:00:00	Alarm time is set to 00:00:00 and is disabled.
Reset	R	Reset is not affected.
Set Time	Shh:mm:ss	Time is not affected.
Trigger Mode	T6	Start on external.
Alternate Output	U	Alternate output is not affected.
Set Date	Vmm:dd	Date is not affected.
Interval Time	W	Interval time is set to 000:010 seconds.
Terminator	Y(LF)	(CR) (LF)
Recall	Z	Recall is not affected.

fect. This is, of course, because of the previous LLO command.

**NOTE**

To get the Model 706 out of the local lockout condition send a GTL (Go To Local) command, refer to paragraph 3.4.3 step 3.

- 3. SPE (Serial Poll Enable)—The serial poll enable sequence is used to obtain the Model 706 status byte. Usually, the serial polling sequence is used to determine which of several devices has requested service over the SRQ line. The serial polling sequence is conducted as follows:
  - A. The controller sets the ATN line true.
  - B. The SPE command is placed on the bus by the controller.
  - C. The Model 706 is addressed to talk.
  - D. The controller sets the ATN line false.
  - E. The instrument then places its status byte on the bus to be read by the controller.
  - F. The controller then sets the ATN line low and places SPD on the bus to end the serial polling sequence.

**SPE Programming Example**—The HP-85 SPOLL statement automatically performs the serial polling sequence. To demonstrate serial polling, momentarily power the unit down and enter the following statements into the HP-85 keyboard.

```
REMOTE 718 (END LINE)
S = SPOLL (718) (END LINE)
DISP S (END LINE)
```

When the END LINE key is pressed after the S = SPOLL 718 statement, the computer performs the serial polling sequence. When the END LINE key is pressed after the DISP S statement the status byte value is displayed on the CRT. The status byte has a value of 0 with this example because all the bits are set to 0.

- 4. SPD (Serial Poll Disable)—The controller automatically sends the SPD command on the bus to end the serial polling sequence in SPE.
- 5. UNT (Untalk)—The controller sends the UNT command to clear the bus of any talkers.
- 6. UNL (Unlisten)—The controller sends the UNL command to clear the bus of any listeners.

**3.4.3 Addressed Commands**

Each of the addressed commands are sent to a specific device on the bus. Each device is selected on the basis of its primary address. The Model 706 responds to these commands only if the primary address of the command is the same as the primary address of the Model 706. All of the following commands are implemented by addressing the Model 706 to listen.

- 1. SDC (Selected Device Clear)—The SDC command performs the same functions as the DCL command except that only the addressed device responds. The instrument returns to the set conditions listed in Table 3-5 when responding to an SDC command. The program memory of the addressed Model 706 is cleared of all previously stored data when an SDC command is received. In addition the buffer and the display pointers are set to location 1.

**SDC Programming Example**—Using front panel controls close channels 1 through 10 on the Model 706 and select the single program mode. Now enter the following statements into the HP-85.

```
REMOTE 718 (END LINE)
CLEAR 712 (END LINE)
```

Notice that when the END LINE key is pressed after the CLEAR 712 statement that the Model 706 did not respond to the SDC because the command was sent with a primary address of 12. Now enter the following statement into the HP-85.

```
CLEAR 718 (END LINE)
```

When the END LINE key is pressed after the CLEAR 718 statement, notice that the instrument returns to the SDC default conditions listed in Table 3-5. Note, that, the program memory is cleared of previously stored data.

- 2. GET (Group Execute Trigger)—The GET command is used to trigger devices to perform a specific action that depends on device configuration. Although GET is considered to be an addressed command, many devices respond to GET without being addressed. Using the GET command is only one of several methods that can be used to start or stop the Model 706 program operation.

**GET Programming Example**—To help illustrate this example first set the Model 706 to a known state, such as the default conditions. Enter the following statements to do this.

```
REMOTE 718 (END LINE)
CLEAR 718 (END LINE)
```

When the END LINE key is pressed after the CLEAR 718 statement the Model 706 reverts to the set conditions listed in Table 3-5. Now enter the following statement into the HP-85 to place the instrument in the continuous program mode and start on GET trigger mode.

```
OUTPUT 718;"P2T2X" (END LINE)
```

Where P2 is the command to set the instrument into the continuous program mode and T2 is the command to set the instrument to the start on GET mode. Now the instrument may be triggered to start with the following statement:



### TRIGGER 718 (END LINE)

After this statement is entered, the front panel START/STOP LED turns on indicating the instrument has been triggered. To stop the program operation enter the following statements into the HP-85.

```
OUTPUT 718; "T3X" (END LINE)
TRIGGER 718 (END LINE)
```

Where T3 is the command to set the instrument into the stop on GET mode. When the END LINE key is pressed after the OUTPUT 718;"T3X" statement the program operation (scanning sequence) is stopped. When the END LINE key is pressed after the TRIGGER 718 statement the START/STOP LED goes out, indicating the instrument has received the trigger.

#### NOTE

Sending any valid command during a scanning sequence STOPS THE SEQUENCE at the presently displayed channel or crosspoint.

The Model 706 also responds to the GET command without addressing. This command is sent with the following HP-85 statement:

```
TRIGGER 7
```

3. GTL (Go To Local)—The GTL command is used to remove the instrument from the remote mode. The REN line MUST BE SET HI (FALSE) in order for the GTL command to restore operation of the locked out Model 706 front panel controls.

**GTL Programming Example**—To illustrate this example the Model 706 must first be placed in the remote and lockout modes. To do this enter the following statements into the HP-85:

```
REMOTE 718 (END LINE)
LOCAL LOCKOUT 7 (END LINE)
```

When the END LINE key is pressed after the LOCAL LOCKOUT 7 statement the Model 706 front panel controls are locked out. Check to see that the REMOTE LED is on and the front panel controls are locked out. The GTL command sequence is automatically sent by the HP-85 statement with the following statement:

```
LOCAL 718 (END LINE)
```

Note, that the REMOTE LED on the front panel turns off, but the front panel controls are still locked out. Front panel control can now be restored by setting the REN line false with the following statement:

```
LOCAL 7 (END LINE)
```

After executing this statement, front panel control is

restored. Setting the REN line false with the LOCAL 7 statement will also take the instrument out of the remote mode.

### 3.5 DEVICE-DEPENDENT COMMANDS

The device-dependent commands allow the user to send the Model 706 commands that perform the same operations as the front panel controls switches except for POWER ON/OFF. There are a number of commands that control parameters which are not available from the front panel and they are listed in Table 3-6. Each command is entered as an ASCII character followed by a specific parameter that is sent over the bus by the controller. The bus treats these commands as data in that the ATN line is high (false) when the commands are transmitted.

Several commands may be grouped together. Before a command or command string is executed, the ASCII character X must be sent. Commands sent without an X (execute) are retained within the command buffer until the execute character is received.

The condition of the status word within the Model 706 is affected by the device-dependent commands. The status word may be obtained from the unit by using commands covered in this section. Refer to paragraph 3.7 for status word information. Illegal commands do not change the mode of the Model 706 but the status byte condition changes as described in paragraph 3.6. Normal Model 706 commands are covered in the following paragraphs. All the device dependent commands for the Model 706 are listed in Table 3-7.

The Model 706 executes the programmed commands in the order listed in Table 3-8. This means that if a statement is entered into the HP-85 as follows:

```
OUTPUT 718; "P1W3.5D1X" (END LINE)
```

The Model 706 executes the commands in the following order according to Table 3-8.

1. Displays interval time (D1).
2. Selects single scan mode (P1).
3. Programs interval time for 3.5 seconds (W3.5).

There are three types of commands that make up the device-dependent commands listed in Table 3-8. They are as follows:

1. Independent Commands—Commands that do not interact with each other.
2. Timer Commands—Commands that control the time and date.
3. Channel Commands—Commands that directly affect the channels.

**Table 3-6. Device-Dependent Commands Not Available to Front Panel**

Command	Definition	Notes
D G	Display Mode Prefix	<p>D4 = Display Message</p> <p>G0 = Channel Data sent with prefix.                      G1 = Channel Data sent without prefix.                      G2 = Buffer State sent with prefix, only closed channels if in P3 mode.                      G3 = Buffer State sent without prefix, only closed channels if in P3 mode.                      G4 = I/O Port sent with prefix.                      G5 = I/O Port sent without prefix.                      G6 = Time/Date sent with prefix.                      G7 = Time/Date sent without prefix.                      G8 = Status Word sent with prefix.                      G9 = Status Word sent without prefix.                      G10 = Settle Time sent with prefix.                      G11 = Settle Time sent without prefix.                      G12 = Alarm Time sent with prefix.                      G13 = Alarm Time sent without prefix.                      G14 = Interval Time sent with prefix.                      G15 = Interval Time sent without prefix.                      G16 = First/Last sent with prefix.                      G17 = First/Last sent without prefix.                      G18 = Previous relay set up buffer location sent with prefix.                      G19 = Previous relay set up buffer location sent without prefix.</p>
K	EOI	<p>K0 = EOI transmitted on last byte out.                      K1 = Send no EOI.</p>
M T	SRQ Trigger	<p>Mnnnn</p> <p>T0 = Start on Talk                      T1 = Stop on Talk                      T2 = Start on GET                      T3 = Stop on GET                      T4 = Start on "X"                      T5 = Stop on "X"                      T6 = Start on External                      T7 = Stop on External</p>
U	Alternate Output	<p>U0 = Channel                      U1 = All Channels                      U2 = I/O                      U3 = Date                      U4 = Status                      U5 = Settling                      U6 = Alarm                      U7 = Interval                      U8 = First/Last                      U9 = Previously recalled buffer location.</p>
Y	Terminator	Yc

**Table 3-7. Model 706 Device-Dependent Commands**

Command	Definition	Notes
A	Set Number of Poles	A0 = Matrix Mode A1 = 1-pole A2 = 2-pole A3 or A4 = 4-pole
B	Display Channel	Bnnnn
C	Close Channel	Cnnnn
D	Display Mode	D0 = Channel D1 = Interval Time D2 = Time D3 = Date D4 = Display Message
E	Date Format	E0 = American Date Format E1 = International Date Format
F	Set First Channel	Fnnnn
G	Prefix	G0 = Channel Data sent with prefix. G1 = Channel Data sent without prefix. G2 = Buffer State sent with prefix. G3 = Buffer State sent without prefix. G4 = I/O Port sent with prefix. G5 = I/O Port sent without prefix. G6 = Time/Date sent with prefix. G7 = Time/Date sent without prefix. G8 = Status Word sent with prefix. G9 = Status Word sent without prefix. G10 = Settle Time sent with prefix. G11 = Settle Time sent without prefix. G12 = Alarm Time sent with prefix. G13 = Alarm Time sent without prefix. G14 = Interval Time sent with prefix. G15 = Interval Time sent without prefix. G16 = First/Last sent with prefix. G17 = First/Last sent without prefix. G18 = Previous relay set up buffer location sent with prefix. G19 = Previous relay set up buffer location sent without prefix.
H	Settle Time	Hnnn.nnn
I	Save	I1, I2, I3, I4, I5...I75, I0 clears all buffers.
J	Debug Test	J0 = Run Debug Test
K	EOI	K0 = EOI transmitted on last byte out K1 = Send no EOI
L	Set Last Channel	Lnnnn
M	SRQ	Mnnnn
N	Open Channel	Nnnnn
O	I/O Port	Onnnn
P	Program	P0 = Step P1 = Single P2 = Continuous P3 = Inspect Mode P4 = Disable Inspect Mode, return to previous P mode.
Q	Set Alarm Time	Qhh:mm:ss

**Table 3-7. Model 706 Device-Dependent Commands**

Command	Definition	Notes
R	Reset	Opens all channels and displays FIRST channel.
S	Set Time	Shh:mm:ss
T	Trigger	T0 = Start on Talk T1 = Stop on Talk T2 = Start on GET T3 = Stop on GET T4 = Start on "X" T5 = Stop on "X" T6 = Start on External T7 = Stop on External
U	Alternate Output	U0 = Channel U1 = All Channels U2 = I/O U3 = Date U4 = Status U5 = Settling U6 = Alarm U7 = Interval U8 = First/Last U9 = Previously recalled buffer location.
V	Set Date	Vmm:dd
W	Set Interval Time	Wnnn.nnn
Y	Terminator	Yc
Z	Recall	Z1, Z2, Z3, Z4, Z5...Z75

Table 3-8. Hierarchy of Command Execution

Command	Definition	Notes
D	Display Mode	D0 = Channel D1 = Interval Time D2 = Time D3 = Date D4 = Display Message
P*	Program	P0 = Step P1 = Single P2 = Continuous P3 = Inspect Mode P4 = Disable Inspect Mode, return to previous P mode.
T*	Trigger Modes	T0 = Start on Talk T1 = Stop on Talk T2 = Start on GET T3 = Stop on GET T4 = Start on "X" T5 = Stop on "X" T6 = Start on External T7 = Stop on External
G*	Prefix Modes	G0 = Channel Data sent with prefix. G1 = Channel Date sent without prefix. G2 = Buffer State sent with prefix. G3 = Buffer State sent without prefix. G4 = I/O Port sent with prefix. G5 = I/O Port sent without prefix. G6 = Time/Date sent with prefix. G7 = Time/Date sent without prefix. G8 = Status Word sent with prefix. G9 = Status Word sent without prefix. G10 = Settle Time sent with prefix. G11 = Settle Time sent without prefix. G12 = Alarm Time sent with prefix. G13 = Alarm Time sent without prefix. G14 = Interval Time sent with prefix. G15 = Interval Time sent without prefix. G16 = First/Last sent with prefix. G17 = First/Last sent without prefix. G18 = Previous relay set up buffer location sent with prefix. G19 = Previous relay set up buffer location sent without prefix.
U*	Alternate Output	U0 = Channel U1 = All Channels U2 = I/O U3 = Date and Time U4 = Status U5 = Settling U6 = Alarm U7 = Interval U8 = First/Last U9 = Previously recalled buffer location.
J*	ROM and LED Test	J0 = Run Debug Test
K*	EOI	K0 = EOI sent on last byte out. K1 = Send no EOI
M*	SRQ	See Table 3-9
O*	I/O Port	0nnn, where 0 = command n = 0 to 377 octal

**Table 3-8. Hierarchy of Command Execution**

Command	Definition	Notes
E**	Date Fromat	E0 = American Date Format E1 = International Date Format
S**	Time	Set Time
V**	Date	Set Date
Q**	Alarm Time	Set Alarm Time
H*	Settle Time	Set Settle Time
W*	Interval Time	Set Interval Time
Y*	Terminator	IEEE Terminator Character
B*	Channel	Display Channel
I***	Channel Save	I1,I2,I3,I4,I5...I75 save a relay set up, I0 clears all buffers.
C***	Close Channel	Close Channel
N***	Open Channel	Open Channel
Z***	Channel Recall	Z1, Z2, Z3, Z4, Z5...Z75 recall a saved relay set up. Overrides close.
F***	Set First Channel	Set First Channel
L***	Set Last Channel	Set Last Channel
A***	Set Number of Poles	If changed First = 1 Last = last channel (100 to 500) and displays channel 1.
R***	Reset	Opens all channels, displays first channel and overrides close, open and recall.

\*Independent Commands  
 \*\*Timer Commands  
 \*\*\*Channel Commands

### 3.5.1 Display Mode

The following five commands set the display mode for the channel, time, date, interval or display message mode.

1. D0— The D0 command sets the Model 706 for the channel display mode.
2. D1— The D1 command sets the Model 706 for the interval time display mode. The interval time is the programmed time the channel is closed. The interval time can be altered by programming inputs, refer to paragraph 3.5.8.
3. D2— The D2 command sets the Model 706 for the time display mode. The time in hours, minutes and seconds is displayed, refer to paragraph 2.6 for time display format.
4. D3— The D3 command sets the Model 706 for the date display mode. The date in month and day is displayed, refer to paragraph 2.6 for date display format.
5. D4— The D4 command sets the Model 706 for the display message mode. The display message mode allows the user to display a customized message on the Model 706 scanner's front panel display.

**Programming Example**— To display and transmit the channel data with a prefix and display the data on the HP-85s CRT enter the following program into the HP-85.

PROGRAM	COMMENTS
10 REMOTE 718 (END LINE)	Sets the Model 706 for the remote mode.
20 CLEAR 7 (END LINE)	Clear the Model 706.
30 OUTPUT 718; "G0D0X"	Display channel mode on 706 display and send channel date with prefix.
40 ENTER 718;A\$ (END LINE)	Obtain data string.
50 DISP A\$ (END LINE)	Display data string.
60 END (END LINE)	End of program.

After typing in the program, press the RUN key on the HP-85 to run the program. After the RUN key is pressed the channel data with a prefix is displayed on the CRT as follows:

C0001,S0

This program can be used for any of the prefix commands (G).

As another example we will illustrate the D4 (display message) mode. Read the following paragraphs and do the programming example.

The ASCII message is of course limited to the display of the seven segment LEDs on the front panel of the Model 706. The messages may be controlled with the following commands:

1. D4aaaaaX—The command is D4 while the letter "a" represents an ASCII character (up to 7 characters may be sent).
2. D0, D1, D2 or D3—Takes the Model 706 out of the display message mode. The Model 706 is placed into the display mode that is programmed.

**NOTE**

For the following notes, refer to the display numbering sequence shown:

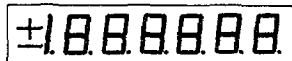

**NOTES**

1. The first character must be a plus (+), minus (-), decimal point or a 1 or it will be ignored.
2. Characters 2 through 7 will accept any displayable ASCII character. Any character not displayable will appear as a "d" segment. A "d" segment is shown as follows:

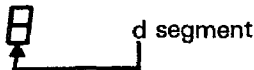

3. The maximum number of characters that can be sent is 7.

**Programming Example**—To display the message "use single scan" enter the following program into the HP-85.

PROGRAM	COMMENTS
10 REMOTE 718 (END LINE)	Set the Model 706 to remote.
20 CLEAR 7 (END LINE)	Clears the Model 706.
30 OUTPUT 718; "D4 USE X" (END LINE)	Displays USE on 706.
40 WAIT 1000 (END LINE)	Wait one second.
50 OUTPUT 718; "D4 SINGLE X" (END LINE)	Displays SINGLE on 706.
60 WAIT 1000 (END LINE)	Wait one second.
70 OUTPUT 718; "D4 SCAN X" (END LINE)	Displays SCAN on 706.
80 WAIT 2000 (END LINE)	Wait two seconds.
90 GO TO 30 (END LINE)	Go to line 30.
100 END (END LINE)	End of program.

**NOTE**

Make sure there is a space in the program between D4 and the message. Otherwise, an erratic display will result.

When the RUN key is pressed the Model 706 displays the following message:

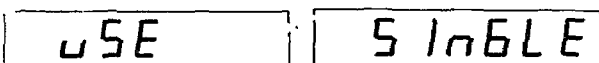

Display operation may be restored by entering the following statement into the HP-85:

OUTPUT 718; "D0X" (END LINE)

**3.5.2 Program (Scan) Mode**

The following three commands set the Model 706 to the Single, Continuous or Step mode.

1. P0—The P0 command sets the Model 706 to the step scan mode. The step scan mode permits the user to scan through the programmed channels one at a time upon sending the P0 command (one channel scanned per P0 command). In using the step scan mode over the bus the interval time must be greater than 10msec.
2. P1—The P1 command sets the Model 706 to the single scan mode. The single scan mode permits one complete scan of the programmed channels.
3. P2—The P2 command sets the Model 706 to the continuous scan mode. The continuous scan mode permits a continuous scan of the programmed channels.
4. P3—The P3 command sets the Model 706 to the inspect mode. The inspect mode is a convenient mode that allows the user to examine the closed channels of a relay set up. The P3 mode in conjunction with the G2 mode allows all the closed channels of a relay set up to be outputted (e.g. displayed on the HP-85's CRT). While the Model 706 is in the P3 mode the middle decimal point is blinking.
5. P4—The P4 command takes the Model 706 out of the inspect mode and returns to previous P (scan) mode.

**P3 Programming Example**—The following example illustrates the P3 (inspect) mode. Using the front panel controls close the odd channels between 1 and 50. Then store the set up in location 001. To illustrate this example type in the following program into the HP-85:

PROGRAM	COMMENTS
10 DIM A\$ [1000] (END LINE)	Defines A\$.
20 REMOTE 718 (END LINE)	Sets the 706 to remote.
30 OUTPUT 718; "Z01X" (END LINE)	Recalls relay set up in location 01.
40 OUTPUT 718; "P3G2X" (END LINE)	Selects the inspect mode and the send buffer state with prefix mode.
50 ENTER 718; A\$ (END LINE)	Obtains data string.
60 DISP A\$ (END LINE)	Display data string.
70 END (END LINE)	End of program.

After typing in the program, press the RUN key on the HP-85

to run the program. After the RUN key is pressed, the channels that are closed (odd channels 1 through 50) are displayed with a prefix on the HP-85's CRT. The display is shown as follows:

```
C0001,S1,C0003,S1,C0005,S1,C0007,S1,
C0009,S1,C0011,S1,C0013,S1,C0015,S1,
C0017,S1,C0019,S1,C0021,S1,C0023,S1,
C0025,S1,C0027,S1,C0029,S1,C0031,S1,
C0033,S1,C0035,S1,C0037,S1,C0039,S1,
C0041,S1,C0043,S1,C0045,S1,C0049,S1
```

To take the Model 706 out of the inspect mode enter the following statement into the HP-85:

OUTPUT 718;"P4X" (END LINE)

After the END LINE key is pressed the Model 706 is taken out of the inspect mode and the middle decimal point (706 display) stops blinking and goes out.

### 3.5.3 Prefix

Some commands may be sent with an identifying prefix or without the prefix, they are listed as follows: Refer to paragraph 3.5.1 for an example program.

1. G0—Sending the G0 command transmits the channel data with a prefix. The format is as follows:

Cnnnn,Sn

where

C = Present Channel

S = Status of Present Channel (O = Open 1 = Closed)

2. G1—Sending the G1 command transmits the channel data without a prefix. The format is as follows:

nnnn,n

3. G2—Sending the G2 command transmits the entire channel buffer state with a prefix. The format is as follows:

```
C0001,Sn
C0002,Sn
.
.
Cnnnn,Sn
```

4. G3—Sending the G3 command transmits the entire channel buffer state without a prefix. The format is as follows:

```
0001,n
0002,n
.
.
nnnn,n
```

5. G4—Sending the G4 command transmits the status of the I/O port with a prefix. The format is as follows:

I/Oiii,ooo

where

i = The input from 0 to 377 octal.

o = The output from 0 to 377 octal.

6. G5—Sending the G5 command transmits the status of the I/O status port without a prefix. The format is as follows:

iii,ooo

7. G6—Sending the G6 command transmits the time and date with prefix. The format is as follows:

Thh:mm:ss,Dmm:dd

8. G7—Sending the G7 command transmits the time and date without a prefix. The format is as follows:

hh:mm:ss,mm:dd

9. G8—Sending the G8 command transmits the status word with a prefix. The status word format is covered in detail in paragraph 3.7.

10. G9—Sending the G9 command transmits the status word without a prefix. The status word format is covered in detail in paragraph 3.7.

11. G10—Sending the G10 command transmits the channel settling time with a prefix. The format is as follows:

Hnnn.nnn

12. G11—Sending the G11 command transmits the channel settling time without a prefix. The format is as follows:

nnn.nnn

13. G12—Sending the G12 command transmits the alarm time with a prefix. The format is as follows:

Qhh:mm:ss

14. G13—Sending the G13 command transmits the alarm time without a prefix. The format is as follows:

hh:mm:ss

15. G14—Sending the G14 command transmits the interval time with a prefix. The format is as follows:

Wnnn.nnn

16. G15—Sending the G15 command transmits the interval time without a prefix. The format is as follows:

nnn.nnn

17. G16—Sending the G16 command transmits the selected first and last channel numbers with a prefix. The format is as follows:

Fnnnn,Lnnnn

18. G17—Sending the G17 command transmits the selected first and last channel numbers with out a prefix. The format is as follows:

nnnn,nnnn

19. G18—Sending the G18 command transmits the relay set up location that was previously used with a prefix. For example: if location 01 was the last recalled location, then the statements:

```
OUTPUT 718; "G18X" (END LINE)
ENTER 718; A$ (END LINE)
DISP A$ (END LINE)
```



Will produce a display on the HP-85 of:

R01

The format for the display is as follows:

Rnn

20. G19—Sending the G19 command transmits the relay set up location that was previously used without prefix. The display is as follows:

nn

### 3.5.4 EOI (End or Identify)

The EOI line on the bus is usually set low by a device during the last byte of its data transfer sequence. In this way, the last byte is properly identified allowing variable length data words to be transmitted. The Model 706 normally sends EOI during the last byte of its data string or status word. The EOI response of the instrument may be set with one of the following commands:

1. K0-Send EOI during last byte.
2. K1-Send no EOI.

#### NOTE

Upon power up the K0 mode is enabled.

**EOI Programming Example**—The EOI response is suppressed with the following HP-85 statement sequence:

```
REMOTE 718; (END LINE)
OUTPUT 718; "K1X" (END LINE)
```

### 3.5.5 Bus Response Mode (SRQ)

The bus response mode determines whether or not the Model 706 requests service from the controller through the SRQ line. When the appropriate mode is selected, the instrument generates an SRQ under the data or error conditions described as follows:

1. If the instrument receives an illegal device-dependent command (IDDC) or illegal device-dependent command option (IDDCO), or if the instrument is not in the remote mode when programmed.
2. If the end of the buffer is encountered when running a program.
3. At the end of interval time.
4. Execution of timer alarm.
5. End of settle time.
6. Broken serial loop.

Upon power up or after a DCL or SDC, SRQ is disabled, the bus response may be programmed as follows:

1. M0-No SRQ
2. M1-M63-Send SRQ.

Refer to Table 3-9 for conditions that generate a SRQ.

#### NOTE

Upon power up, the M0 mode is selected. The SRQ byte is cleared on a read of the serial poll byte.

**Table 3-9. SRQ Commands and Conditions**

SRQ Command	Broken* Serial Loop	End of* Settle Time	Interval* Time	End of* Scan	Timer* Alarm	IDDC, IDDCO,* No Remote
M0**						
M1						X
M2					X	
M3					X	X
M4				X		
M5				X		X
M6				X	X	
M7				X	X	X
M8			X			
M9			X			X
M10			X		X	
M11			X		X	X
M12			X	X		
M13			X	X		X
M14			X	X	X	
M15			X	X	X	X
M16		X				
M17		X				X
M18		X			X	
M19		X			X	X
M20		X		X		
M21		X		X		X

Table 3-9. SRQ Commands and Conditions

SRQ Command	Broken* Serial Loop	End of* Settle Time	Interval* Time	End of* Scan	Timer* Alarm	IDDC, IDDCO* No Remote
M22		X		X	X	
M23		X		X	X	X
M24		X	X			
M25		X				X
M26		X	X		X	
M27		X	X		X	X
M28		X	X	X		
M29		X	X	X		X
M30		X	X	X	X	
M31		X	X	X	X	X
M32	X					
M33	X					X
M34	X				X	
M35	X				X	X
M36	X			X		
M37	X			X		X
M38	X			X	X	
M39	X			X	X	X
M40	X		X			
M41	X		X			X
M42	X		X		X	
M43	X		X		X	X
M44	X		X	X		
M45	X		X	X		X
M46	X		X	X	X	
M47	X		X	X	X	X
M48	X	X				
M49	X	X				X
M50	X	X			X	
M51	X	X			X	X
M52	X	X		X		
M53	X	X		X		X
M54	X	X		X	X	
M55	X	X		X	X	X
M56	X	X	X			
M57	X	X	X			X
M58	X	X	X		X	
M59	X	X	X		X	X
M60	X	X	X	X		
M61	X	X	X	X		X
M62	X	X	X	X	X	
M63	X	X	X	X	X	X

\*Indicates conditions that generate an SRQ.

\*\*M0 disables SRQ.



**SRQ Programming Example** — The bus response mode may be programmed as follows:

REMOTE 718 (END LINE)  
OUTPUT 718; "M1X" (END LINE)

The SRQ format is as follows:

Mnnn

Where

M = Bus response mode.

n = 0 to 255 (base 10), in base 2 NNNNNNNN.

**SRQ MASK**

MSB								LSB
7	6	5	4	3	2	1	0	
N/A	N/A	1= BROKEN SERIAL LOOP	1=END OF SETTLE TIME	1=END OF INTERVAL TIME	1=END OF SCAN	1= TIMER ALARM	1= IDDCO, IDDC OR NO REMOTE	

**SRQ BYTE**

MSB								LSB
7	6	5	4	3	2	1	0	
N/A	SRQ	0	END OF SETTLE TIME	END OF INTERVAL TIME	END OF SCAN	TIMER ALARM	N/A	
DATA ERROR	SRQ	1	N/A	BROKEN SERIAL LOOP	NO REMOTE	IDDCO	IDDC	

**SRQ Mask** — In order to facilitate SRQ programming, the Model 706 makes use of a mask when generating a SRQ. When the appropriate bit in the mask is set, the instrument generates a SRQ when those particular conditions exist. The SRQ mask byte format is shown. Bits within the mask can be controlled by sending the ASCII character "M" followed by a decimal number from 0 to 63. Table 3-9 lists the conditions that cause a SRQ for each command parameter. Note that the instrument can be programmed for one or more conditions simultaneously.

**3.5.6 Trigger Modes**

Triggering is used to tell the Model 706 to initiate the program mode sequence (single, continuous or step). The trigger stimulus may come from commands sent over the bus, through the external input or by the front panel START/STOP button. Triggering may be either to start the program mode sequence or stop the sequence. The trigger modes are as follows:

1. T0 — In the T0 mode (Start on Talk) talk command initiates the program mode sequence.
2. T1 — In the T1 mode (Stop on Talk) a talk command stops the program mode sequence.
3. T2 — In the T2 mode (Start on GET) a GET command initiates the program mode sequence.
4. T3 — In the T3 mode (Stop on GET) a GET command stops the program mode sequence.

5. T4 — In the T4 mode (Start on X) an execute command "X" initiates the program mode sequence.
6. T5 — In the T5 mode (Stop on X) an execute command "X" stops the program mode sequence.
7. T6 — In the T6 mode (Start on External) an external trigger initiates the program mode sequence.
8. T7 — In the T7 mode (Stop on External) an external trigger stops the program mode sequence.

**NOTE**

The T modes may also be used in the matrix mode to advance through the matrix set up. One trigger command sent for every crosspoint.

**Programming Example**—Set the instrument to its default condition by turning the unit off then on and enter the following statements into the HP-85 keyboard:

REMOTE 718 (END LINE)  
OUTPUT 718; "T2X" (END LINE)

After the END LINE key is pressed the second time, the instrument is placed in the start on GET trigger mode. When a GET command is sent by the controller the Model 706 triggers. To send a GET command, enter the following statement into the HP-85.

TRIGGER 718 (END LINE)

**Programming Note** — If the Model 706 is in the trigger mode T0 (Start on Talk), either of the following HP-85 BASIC statements will initiate a scan:

SEND 7; TALK 18  
S=SPOLL (718)

Requesting data from the Model 706 will stop the scan. The statement:

ENTER 718; A\$

does not initiate a scan since the controller addresses the Model 706 to talk and then requests data in the same statement.

**3.5.7 Programmable Terminator (Y)**

The Model 706 uses special terminator characters to mark the end of its data string. To allow a wide variety of controllers to be used, the terminator can be changed by sending the appropriate command over the bus. The power up default value is the commonly used carriage return, line feed (CR LF) sequence. The terminator assumes this default value upon power up or after the instrument receives a DCL (Device Clear) or SDC (Selective Device Clear).

The terminator may be programmed by sending the ASCII character Y followed by the desired terminator character. Any ASCII character except one of the following may be used: all capital letters, all numbers, Blank, +, -, /, (, ), ., e, :

Special command characters will program the instrument for



special terminator sequences as follows:

1. Y(LF) = CR LF (Two terminators)
2. Y(CR) = LF CR (Two terminators)
3. Y(DEL) = No terminator

#### NOTE

Most controllers use the CR or LF character to terminate their input sequences. Using a nonstandard terminator may cause the controller to hang up unless special programming is used.

**Programming Example**—Enter the following statements into the HP-85 keyboard:

```
REMOTE 718 (END LINE)
OUTPUT 718; "YtX" (END LINE)
ENTER 718; t$ (END LINE)
```

After END LINE is pressed the first time the Model 706 is placed in the remote mode. After END LINE is pressed the second time the terminator is changed to the ASCII character T. After END LINE is pressed the third time, the HP-85 ceases to operate because it is waiting for the standard terminator sequence. The HP-85 may be reset by holding down the SHIFT key and then pressing RESET on the keyboard.

### 3.5.8 Inputs

#### 1. Set Number of Poles (A)

The letter A is the command to set the Model 706 into one of the pole configurations or the matrix mode. There are three different pole configurations and they are as follows:

- A0 = Matrix Mode
- A1 = 1-pole Mode
- A2 = 2-pole Mode
- A3 or A4 = 4-pole Mode

**Programming Example**—Enter the following statements into the HP-85 to program the Model 706 into the 4-pole mode.

```
REMOTE 718 (END LINE)
OUTPUT 718; "A3X" (END LINE)
```

When the END LINE key is pressed the second time, the Model 706 is placed in the 4-pole mode. To verify the Model 706 is now in the 4-pole mode, press PRGM, 6 and note the front panel display. Press ENTER to return to normal display.

**Programming Example**—Enter the following statements into the HP-85 to program the Model 706 into the matrix mode.

```
REMOTE 718 (END LINE)
OUTPUT 718; "A0X" (END LINE)
```

When the END LINE key is pressed the second time, the

Model 706 is placed in the matrix mode and the display is as follows:

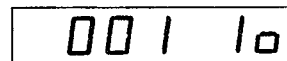

This format is explained as follows:

nnn m O or C

Where:

nnn is a three digit number displaying the column, card # and unit #.

m is the row from 1 to 4.

o or c denotes open or closed.

As an example, consider the following display

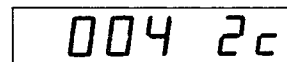

Where:

004 Denotes unit #1 (001 through 050 denotes unit #1).  
004 Also, denotes card #1 (001 through 005 denotes card #1).

004 Also, denotes column #4.

2 denotes row #2

c denotes the crosspoint is closed

Therefore, the display 004 2 c means that the crosspoint of unit #1, card #1, column #4, row #2 is closed. The programming statement that depicts this crosspoint is as follows:

```
OUTPUT 718; "C0042X" (END LINE)
```

To display the previously programmed crosspoint on the Model 706s display enter the following statement into the HP-85.

```
OUTPUT 718; "B0042X" (END LINE)
```

Now, return the Model 706 to the 2-pole mode by entering the following statement into the HP-85 keyboard:

```
OUTPUT 718; "A2X" (END LINE)
```

The 1-pole mode is available only on the Model 7056 scanner card. On the card, relay K111 is the output relay for the even channels and relay K112 is the output relay for the odd channels. These relays close when the appropriate channel relays close. In the 1-pole mode, each channel relay on the 7056 scanner card controls two channels. This is because they are the same relay. For example, if the channel 1 relay is closed, then the channel 2 relay is also closed because they are the same relay. The closed channels do not reach the output unless the appropriate output relay is closed.

In some situations this may close channels that are not programmed as closed. For example, if channels 1 and 4 are programmed as closed, then because of the scanner card's architecture, channels 2 and 3 are also closed. Refer to the following chart.

1-Pole Nomenclature	2-Pole Nomenclature
Channel 1 =	Channel 1 Relay + Output Relay K112

Channel 2 = Channel 1 Relay + Output Relay K111  
Channel 3 = Channel 2 Relay + Output Relay K112  
Channel 4 = Channel 2 Relay + Output Relay K111

Channel 19 = Channel 10 Relay + Output Relay K112  
Channel 20 = Channel 10 Relay + Output Relay K111

## 2. Display Channel (B)

The letter B is the command to program the Model 706 to display a particular channel. The format for the display channel command is as follows:

Bnnnn

where:

B = Display channel command.

n = Number of channel.

**Programming Example**—Enter the following statements into the HP-85 to program the Model 706 to display channel 7.

```
REMOTE 718 (END LINE)
OUTPUT 718; "B7X" (END LINE)
```

The number of channels for a particular configuration is determined by the number of poles, and Model 706's daisy chained together. If the channel specified in the statement is greater than the highest available channel, the Model 706 gives an IDDCO and then returns to the previously displayed channel. Take note of the front panel display upon pressing END LINE the second time. Channel 7 should be displayed.

## 3. Close Channel (C)

The letter C is the command to close a particular channel. The format for the closed channel command is as follows:

Cnnnn

where:

C = Close channel command.

n = Number of channel.

**Programming Example**—Enter the following statements into the HP-85 program Model 706 to close channel 7.

```
REMOTE 718 (END LINE)
OUTPUT 718; "C7X" (END LINE)
```

Take note of the front panel display upon pressing END LINE the second time. Channel 7 should be closed.

Multiple channels can be closed simultaneously over the bus. For example, close channels 1-10 by entering the following statement into the HP-85 keyboard:

```
OUTPUT 718; "C1 C2 C3 C4 C5 C6 C7 C8 C9
C10X" (END LINE)
```

Use the display channel command (B) to verify that each channel has closed. Refer to Table 2-15 for the maximum number of relays that can be closed simultaneously.

### NOTE

The number of channels for a particular configuration is determined by the number of poles, and Model 706's daisy chained together.

## 4. Display Mode (D)

The letter D is the command to set a particular display mode. There are five display modes and they are as follows:

D0 = Display Channel

D1 = Display Interval Time

D2 = Display Time

D3 = Display Date

D4 = Display Message

**Programming Example**—Enter the following statements into the HP-85 to display the date.

```
REMOTE 718 (END LINE)
OUTPUT 718; "D3X" (END LINE)
```

When END LINE is pressed the second time, the Model 706 displays the date.

## 5. Set Date Format (E)

The letter E is the command to program the Model 706 to set the date format for american date format or the international date format. The two formats are as follows:

E0 = American Date Format: mm.dd

E1 = International Date Format: dd.mm

**Programming Example**—Enter the following statements into the HP-85 to set the international date format.

```
REMOTE 718 (END LINE)
OUTPUT 718; "D3X" (END LINE)
OUTPUT 718; "E1X" (END LINE)
```

When END LINE is pressed the third time, the Model 706 is programmed for the international date format.

### NOTE

Do not place the set date format (E) command after another command in the same string. The Model 706 will process the E command as an exponent for scientific notation and create an invalid condition. Use the E command in a separate string.

Use the following statement to return the Model 706 to the display channel mode:

```
OUTPUT 718; "D0X" (END LINE)
```

## 6. Set First Channel (F)

The letter F is the command to program a specific channel as the first channel. Any channel within the limits of the specified channels can be programmed as the first channel. The format for the set first channel command is as follows:

Fnnnn

where:

F = Set first channel command.

n = Number of channel.

**Programming Example**—Enter the following statements into the HP-85 to set channel five as the first channel.

REMOTE 718 (END LINE)  
OUTPUT 718; "F5X" (END LINE)

When END LINE is pressed the second time, the Model 706 sets channel five as the first channel. To display the channel mode send a D0 command. To display channel 5 send a B5.

### NOTE

The number of channels for a particular configuration is determined by the number of poles, and Model 706's daisy chained together.

## 7. Prefix (G)

When the Model 706 is addressed to talk, the instrument sends a data string containing information on programmed channel data. Through the use of the prefix command, the operator has control over whether or not, the instrument sends the appropriate prefixes imbedded in the data string. Refer to paragraph 3.5.1 for an example program. The 19 prefix commands are as follows:

G0—Channel data transmitted with prefix.

Cnnnn,Sn

where:

C = Present Channel

S = Status of Present Channel (N = 0 = open,  
N = 1 = closed)

nnnn = Number of Present Channel

G1—Channel data transmitted without prefix.

nnnn,n

G2—Entire channel buffer state transmitted with prefix.

C0000,Sn

C0001,Sn

- 
- 

Cnnnn,Sn

G3—Entire channel buffer state transmitted without prefix.

0000,n

0001,n

- 
- 

nnnn,n

G4—I/O status port transmitted with prefix.

I/O iii,ooo

where:

i = Input from 0 to 377 octal.

o = Output from 0 to 377 octal.

G5—I/O status port transmitted without prefix.

iii,ooo

G6—Time and date transmitted with prefix

(AMR/INT) Thh:mm:ss, Ddd:mm

where:

T = Time in hours, minutes and seconds.

D = Date in days and months.

G7—Time and date transmitted without prefix

hh:mm:dd, mm:dd

G8—Status word transmitted with prefix.

706 ADEJKPTG M Y

706 110000000000:

G9—Status word transmitted without a prefix.

ADEJKPTG M Y

110000000000:

G10—Channel settle time transmitted with prefix.

Hnnn.nnn

G11—Channel settle time transmitted without prefix.

nnn.nnn

G12—Alarm time transmitted with prefix.

Qhh:mm:ss

G13—Alarm time transmitted with prefix.

hh:mm:ss

G14—Interval time transmitted with prefix.

Wnnn.nnn

G15—Interval time transmitted without prefix.

nnn.nnn

G16—First and last channel numbers transmitted with prefix.

Fnnnn,Lnnnn

G17—First and last channel numbers transmitted without prefix.

nnnn,nnnn

G18—Previously recalled buffer location (relay set up) transmitted with prefix.

Rnn

G19—Previously recalled buffer location (relay set up) transmitted without prefix.

nn

## 8. Set Channel Settle Time (H)

The letter H is the command to set the channel settle time. The channel settle time is the programmed time each channel has to settle. The format for this command is in seconds and is as follows:

Hnnn.nnn



OUTPUT 718; "J0X" (END LINE)

**NOTES:**

1. Other operating parameters are not affected by the J0 command.
  2. RAM is not tested by the J0 command but is tested upon power up.
11. **EOI (End or Identify) (K)**

The letter K is the command that programs the Model 706 to either send or not send EOI on the last byte out on a multiple byte sequence. EOI response of the instrument may be programmed as follows:

- K0—Send EOI during last byte.
- K1—Send no EOI.

Upon power up, or after receiving a SDC or DCL command, the Model 706 will be in the K0 mode.

**Programming Example**—The EOI will be suppressed with the following statement sequence:

REMOTE 718 (END LINE)  
OUTPUT 718; "K1X" (END LINE)

Note, that, the HP-85 does not rely on EOI to mark the end of the data transmission. Some controllers, however, may require that EOI be present at the end of transmission.

**NOTE**

In the G2 and G3 prefix modes, EOI is transmitted only at the end of the complete program memory transmission; not during the last byte of each IEEE buffer or memory location.

12. **Set Last Channel (L)**

The letter L is the command to program a specific channel as the last channel. The last channel must be at least one channel ahead of the first channel otherwise, the scan sequence will not operate properly. For example, if the first channel is programmed to be 5, then the last channel must be specified as at least 6. The format for set last channel configuration is as follows:

Lnnnn

where:

- L = Set last channel command.
- n = Number of channel.

**Programming Example**—Enter the following statements into the HP-85 to set channel 10 as the last channel.

REMOTE 718 (END LINE)  
OUTPUT 718; "L10X" (END LINE)

When END LINE is pressed the second time, the Model 706 sets channel 10 as the last channel. To display channel 10 and

verify it is programmed as the last channel, type the following statement into the HP-85:

OUTPUT 718; "B10X" (END LINE)

**NOTE**

The number of channels for a particular configuration is determined by the number of poles and Model 706 units daisy chained together.

13. **SRQ (M)**

The letter M is the SRQ command mode. The SRQ mode controls which conditions within the instrument generates a SRQ (Service Request). Once a SRQ has been generated, the status can be checked to determine if the SRQ was generated by the Model 706. In addition, other bits in the status byte are sent depending on certain data and error conditions. For more information concerning the SRQ byte and SRQ mask refer to paragraph 3.5.5.

14. **Open Channel (N)**

The letter N is the command to open a specific channel. The format for the open channel command is as follows:  
Nnnnn

where:

- N = Open channel command.
- n = Number of channel.

**Programming Example**—Enter the following statements into the HP-85 to program the Model 706 to open channel 7.

REMOTE 718 (END LINE)  
OUTPUT 718; "N7X" (END LINE)

When END LINE is pressed the second time, the Model 706 opens channel 7. To display 7 and verify it is open, type the following statement into the HP-85:

OUTPUT 718; "B7X" (END LINE)

**NOTE**

The number of channels for a particular configuration is determined by the number of poles and Model 706 units daisy chained together.

15. **I/O Port (O)**

The letter O is the I/O port command. It controls the status of the eight output bits on the display I/O port on the rear panel of the Model 706. The format for the I/O port command is as follows:

Onnn

where:

- O = I/O Port Command
- n = 0 to 377 Octal

Converting the octal base of n to correspond to base 2, eight outputs for the digital I/O outputs is as follows:



nnn = nnnnnnnn if 0, the bit is low.

(octal) binary) if 1, the bit is high.

Example: 077 = 00111111

(Octal) = (Binary)

The I/O port command consists of the ASCII O character followed by the decimal number that sets the control bits. Upon power up, or after a DCL or SDC command, the eight output lines are set low. Table 3-10 lists all digital I/O port contact pin assignments. Figure 3-5 shows the contact pin locations. The maximum current drawn from the digital I/O port is 350mA. This includes the relay card and the output. The current limiting resistor is 68Ω.

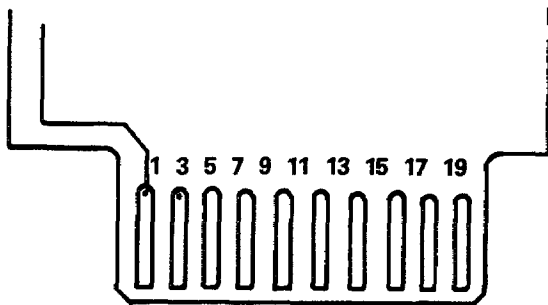

**EVEN NUMBERED PINS ARE ON OTHER SIDE OF BOARD.**

**Figure 3-5. Digital I/O Port Pin Assignment**

**Table 3-10. Digital I/O Port Contact Pin Assignment**

Pin Number	Connection
1	+5 Volts (for reference only)
2	+5 Volts (for reference only)
3	IEEE Common
4	IEEE Common
5	Input (Bit 7)
6	Output (Bit 7)
7	Input (Bit 6)
8	Output (Bit 6)
9	Input (Bit 5)
10	Output (Bit 5)
11	Input (Bit 4)
12	Output (Bit 4)
13	Input (Bit 3)
14	Output (Bit 3)
15	Input (Bit 2)
16	Output (Bit 2)
17	Input (Bit 1)
18	Output (Bit 1)
19	Input (Bit 0)
20	Output (Bit 0)

**Programming Example**—Enter the following statements into the HP-85 to set the eight output lines high and display the result on the HP-85 CRT.

PROGRAM	COMMENTS
10 REMOTE 718 (END LINE)	Sets Model 706 to remote mode.
20 CLEAR 7 (END LINE)	Clears Model 706.
30 OUTPUT 718; "O377X" (END LINE)	Sets Digital I/O outputs high.
40 OUTPUT 718; "G4X" (END LINE)	Sends I/O status port with prefix.
50 ENTER 718; A\$ (END LINE)	Obtain data sting.
60 DISP A\$ (END LINE)	Display data string.
70 END (END LINE)	End of program.

When the RUN key is pressed the eight output lines will go high and the following is displayed on the HP-85 CRT.

I/O XXX,377

**NOTE**

With no connections on the digital I/O inputs they are undefined.

**16. Program (P)**

The letter P is the command to select one of the three scanning modes and to enable or disable the inspect mode. The scanning modes are explained in detail in paragraph 2.5.4. The format for each of the program modes is as follows:

- P0—Step Mode
- P1—Single Mode
- P2—Continuous Mode
- P3—Inspect Mode
- P4—Disble Inspect Mode, return to previous P mode.

**Programming Example**—Enter the following statements into the HP-85 to program the Model 706 into the continuous mode.

REMOTE 718 (END LINE)  
OUTPUT 718; "P2X" (END LINE)

When the END LINE key is pressed the second time the Model 706 is programmed into the continuous program mode. Look at the front panel continuous LED to verify that the continuous scan mode was activated. The continuous LED should be on.

**17. Set Alarm Time (Q)**

The letter Q is the command to set the alarm time. For example, if the alarm time is set for 11:30:00 a TTL level negative going pulse of greater than 10μsec appears at the SERIAL OUT output connector on the rear panel of the instrument at 11:30 AM everyday until changed. This pulse can be used to inform another instrument or device to initiate a scan sequence or open a channel on the Model 706. The format for the alarm time command is as follows:

Qhh:mm:ss

where:

- Q = Alarm time command.
- h = Hours
- m = Minutes
- s = Seconds

**Programming Example**—Enter the following statements into the HP-85 to program the alarm time for 2:15 pm and display the alarm time on the HP-85 CRT.

PROGRAM	COMMENTS
10 REMOTE 718 (END END LINE)	Sets Model 706 to remote mode.
20 CLEAR 7 (END LINE)	Clears Model 706.
30 OUTPUT 718; "Q14:15: 00X" (END LINE)	2:15 pm.
40 OUTPUT 718; "G12X" (END LINE)	Transmits alarm time with prefix.
50 ENTER 718; A\$ (END LINE)	Obtains data string.
60 DISP A\$ (END LINE)	Displays data string.
70 END (END LINE)	End of program.

When the RUN key is pressed, the alarm time is set for 2:15 pm. The alarm time is also displayed on the HP-85 CRT.

**NOTE**

When the format of the programmed time is not the full six digits (hh:mm:ss) the Model 706 truncates the time to what is programmed. If in this example the last two zeroes were left out the time would be programmed for 14 minutes 15 seconds AM. The colons between the hours, minutes and seconds are optional.

**18. Reset (R)**

The letter R is the command that programs the Model 706 to reset conditions. The reset conditions are: all channels open and display the specified first channel. R1 thru R75 clears the corresponding buffer location.

**Programming Example**—Enter the following statements into the HP-85 to reset the Model 706.

REMOTE 718 (END LINE)  
OUTPUT 718; "RX" (END LINE)

When the END LINE key is pressed the second time, the Model 706 goes to the reset condition.

**NOTE**

The first channel was set to 5 in a previous example. When the END LINE key is pressed the second time the Model 706 should display the following:

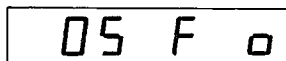

**19. Set Time (S)**

The letter S is the command to program the Model 706 to

set the time. The format is as follows:

S hh:mm:ss

where:

- S = Set time command.
- h = Hours
- m = Minutes
- s = Seconds

**Programming Example**—Enter the following statements into the HP-85 to set the time to 5:00 pm.

REMOTE 718 (END LINE)  
OUTPUT 718; "D2S17:00:00X" (END LINE)

When the END LINE key is pressed the second time, the Model 706 displays the time and sets it to 5:00 pm.

**NOTE**

When the format of the programmed time is not the full six digits (hh:mm:ss) the Model 706 truncates the time to what is programmed. If in this example the last two zeroes are left out the time would be programmed for 17 seconds not 5:00 pm. The colons between the hours, minutes and seconds are optional.

**20. Trigger Modes (T)**

The trigger commands control the stimulus to be used to start or stop Model 706 program operation. Basically, the trigger stimulus controls instrument operation much like the front panel START/STOP button does, except that the trigger stimulus can control either start or stop (not both), depending on the selected trigger mode. Model 706 trigger modes are:

- T0—Start on talk.
- T1—Stop on talk.
- T2—Start on GET.
- T3—Stop on GET.
- T4—Start on "X".
- T5—Stop on "X".
- T6—Start on external.
- T7—Stop on external.

**NOTES**

1. In the step (manual) program mode, the instrument advances one channel location with each trigger stimulus.
2. When the instrument is triggered to start, program execution begins at the present channel location.
3. Sending a trigger over the bus while in the matrix mode displays the Recall message along with the present buffer location. Sending a trigger (in the appropriate trigger mode) over the bus while in the matrix mode and the Recall message is displayed advances the instrument to the next buffer location. Refer to paragraph 2.9.6.

**Programming Example**—In the following programming example the Model 706 is programmed to scan channels 1 through 50 at a 500msec rate upon receiving a GET command.

PROGRAM	COMMENTS
10 REMOTE 718 (END LINE)	Programs Model 706 into the remote mode.
20 CLEAR 7 (END LINE)	Clears Model 706.
30 OUTPUT 718; "D0F1L 50W.5T2P2X" (END LINE)	Programs the Model 706 for display channel mode, channel 1 as first channel, channel 50 as last, interval time is 500msec, continuous scan mode and start on GET mode.
40 TRIGGER 718	Provides GET command.
50 DISP "PRESS CONT TO STOP PROGRAM"	Displays message on HP-85.
60 PAUSE	Program pause.
70 CLEAR 7	Clears Model 706.
80 END	End of program.

Press the RUN key on the Model 706 to start the program. After the RUN key is pressed the Model 706 scans channel 1 through 50 at the 500msec rate. The start on GET command in (T2) line 30 programs the Model 706 to start the scan upon receiving a GET command. In this program the GET command is provided by the TRIGGER statement. To stop the program press the CONT. key. To resume the program press the RUN key.

#### NOTE

Sending any valid command during a scanning sequence, STOPS THE SEQUENCE at the presently displayed channel or crosspoint.

#### 21. Set Date (V)

The letter V is the command to set the date. The format for the set date command is as follows:

Vmm:dd (American)

Vdd:mm (International)

**Programming Example**—Enter the following statements into the HP-85 to program the date for July 12th.

```
REMOTE 718 (END LINE)
OUTPUT 718; "V12:07X" (END LINE)
OUTPUT 718; "D3X" (END LINE)
```

When END LINE is pressed the second time, the Model 706 sets the date for July 12th in international format when the END LINE key is pressed the third time the date is displayed on the Model 706. For american format the second statement would be:

```
OUTPUT 718; "V07:12X" (END LINE)
```

The date (american or international) must appear in the statement as a four digit number. If three digits are used instead of four the Model 706 moves the three digits to the right by one place. For example, enter the following statement into the HP-85.

```
OUTPUT 718; "V123X" (END LINE)
```

When the END LINE key is pressed the date is set to 01.23 which is January 23rd in the American format. If two or less digits are used instead of four digits the Model 706 displays an IDDCO (Illegal Device-Dependent Command Option) and does not change the present date. The colon between the month and day in the statement is optional.

#### 22. Set Interval Time (W)

The letter W is the command to set the interval time in seconds. The maximum interval time is the programmed time for the channel to be closed. The format for the interval time command is as follows:

Wnnn.nnn

where:

W = Set interval time command.

n = Number of seconds.

**Programming Example**—Enter the following statements into the HP-85 to program the interval time to three seconds.

```
REMOTE 718 (END LINE)
OUTPUT 718; "W003.00X" (END LINE)
```

When the END LINE key is pressed the second time, the Model 706 sets the interval time to three seconds. To verify that the interval time has been set to three seconds send a D1 command. This is the command to display the interval time.

In the second statement the leading and trailing zeroes are optional. As long as the decimal point is entered in the appropriate place the leading and trailing zeroes are optional. The interval time format on the Model 706 display is always six digits.

#### 23. Programming Terminator (Y)

The Model 706 uses special terminator characters to mark the end of its data string. To allow a wide variety of controller's to be used, the terminator can be changed by sending the appropriate command over the bus. For more information and a programming example refer to paragraph 3.5.7.

#### 24. Alternate Outputs (U)

The letter U is the command to program the Model 706 to transmit the status word, settle time, alarm time, interval time or first/last channel data on talk. The alternate output can also transmit the U commands with or without a prefix.

**Programming Example**—To send and display the time and date enter the following program into the HP-85:

PROGRAM	COMMENTS
10 REMOTE 718 (END LINE)	Model 706 set to remote.

20 CLEAR 7 (END LINE)	Clears Model 706.
30 OUTPUT 718; "U3X" (END LINE)	Sends time and date.
40 ENTER 718; A\$	Obtain data string.
50 DISP A\$	Display data string.
60 END	End of program.

The commands are as follows:

U0—Sending the U0 command outputs the present channel number. The present channel number can be sent with or without a prefix depending on the present prefix mode (G). Refer to the flowchart in Figure 3-6 for the sequence of sending the U and G modes. Refer to paragraph 3.5.8 step 7 for information concerning the prefix modes and their formats.

U1—Sending the U1 command outputs all the channel numbers. All the channel numbers can be sent with or without a prefix depending on the present prefix mode (G). Refer to the flowchart in Figure 3-6 for the sequence of sending the U and G modes. Refer to paragraph 3.5.8 step 7 for information concerning the prefix modes and their formats.

U2—Sending the U2 command outputs the digital I/O port status. The digital I/O port status can be sent with or without a prefix depending on the present prefix mode (G). Refer to flowchart in Figure 3-6 for the sequence of sending the U and G modes. Refer to paragraph 3.5.8 step 7 for information concerning the prefix modes and their formats.

U3—Sending the U3 command outputs the time and date. The time and date can be sent with or without a prefix depending on the present prefix mode (G). Refer to the flowchart in Figure 3-6 for the sequence of sending the U and G modes. Refer to paragraph 3.5.8 step 7 for information concerning the prefix modes and their formats.

U4—Sending the U4 command outputs the status word. The status word can be sent with or without a prefix depending on the present prefix mode (G). Refer to the flowchart in Figure 3-6 for the sequence of sending the U and G modes. Refer to paragraph 3.5.8 step 7 for information concerning the prefix modes and their formats.

U5—Sending the U5 command outputs the channel settle time. The channel settle time can be sent with or without a prefix depending on the present prefix mode (G). Refer to the flowchart in Figure 3-6 for the sequence of sending the U and G modes. Refer to paragraph 3.5.8 step 7 for information concerning the prefix modes and their formats.

U6—Sending the U6 command outputs the alarm time. The alarm time can be sent with or without a prefix depending on the present prefix mode (G). Refer to the flowchart in Figure 3-6 for the sequence of sending the U and G modes. Refer to paragraph 3.5.8 step 7 for information concerning the prefix modes and their formats.

U7—Sending the U7 command outputs the interval time. The interval time can be sent with or without a prefix depending on the present prefix mode (G). Refer to the flowchart in Figure 3-6 for the sequence of sending the U and G modes. Refer to paragraph 3.5.8 step 7 for information concerning the prefix modes and their formats.

U8—Sending the U8 command outputs the programmed first and last channel. The programmed first and last channel can be sent with or without a prefix depending on the present prefix mode (G). Refer to the flowchart in Figure 3-6 for the sequence of sending the U and G modes. Refer to paragraph 3.5.8 step 7 for information concerning the prefix modes and their formats.

U9—Sending the U9 command outputs the previously called buffer location. The buffer location can be sent with or without a prefix depending on the present prefix mode (G). Refer to the flowchart in Figure 3-6 for the sequence of sending the U and G modes. Refer to paragraph 3.5.8 step 7 for information concerning the prefix modes and their formats.

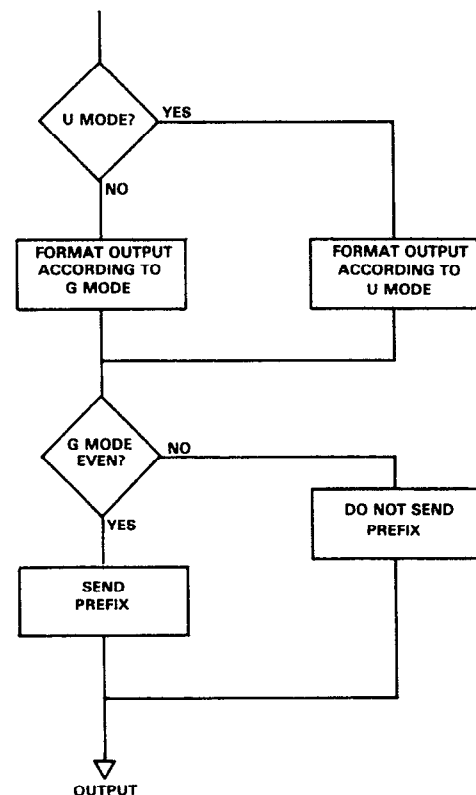

Figure 3-6. U and G Mode Sequence

### 3.6 STATUS BYTE FORMAT

The status byte contains information relating to data and error conditions within the instrument. The controller obtains the status byte by using the serial polling sequence (SPE) described in paragraph 3.4.2. Once the byte resides in the

computer, the information in Figure 3-7 can be used when interpreting data and error conditions.

Bit six is the SRQ bit. If this bit is set the service request was made by the Model 706. Bit five determines the meaning of bits zero through three. If bit five is set, the error conditions listed in Table 3-9 apply to bits zero through three. If bit five is cleared, the data condition listed in the table apply.

To output the status byte in binary form (Figure 3-7) enter the following program into the HP-85.

PROGRAM	COMMENTS
10 REMOTE 718 (END LINE)	Programs the Model 706 into the remote mode.
20 S = SPOLL (718) (END LINE)	Start serial poll sequence.
30 DISP "B7 B6 B5 B4 B3 B2 B1 B0" (END LINE)	Display contents of quotation mark.
40 FOR I=7 to 0 STEP -1 (END LINE)	Loop eight times.
50 DISP BIT (S,I); (END LINE)	Display status byte.
60 NEXT I (END LINE)	
70 DISP (END LINE)	
80 END (END LINE)	

Press the RUN key to start the program. After the RUN key is pressed the Model 706 outputs the status byte to the controller. The controller then displays the status byte in the form shown in Figure 3-7.

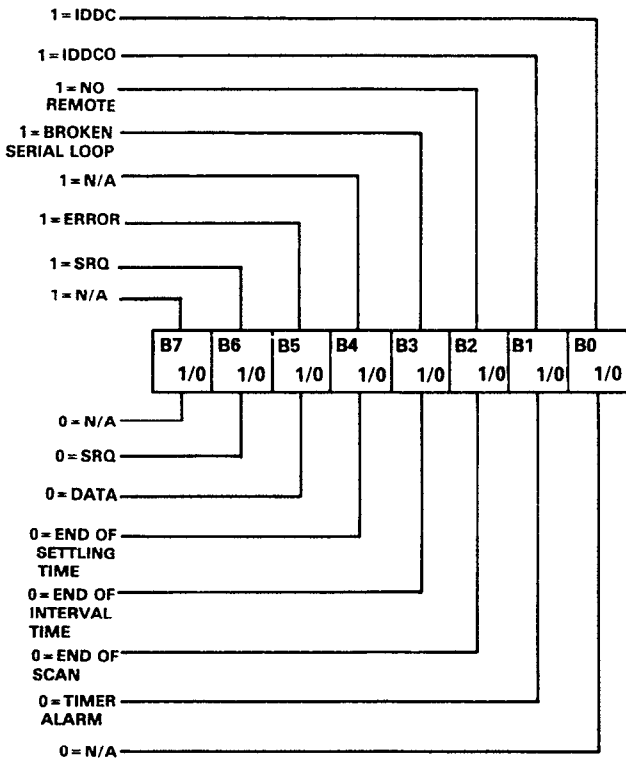

Figure 3-7. Status Byte Format

### 3.7 STATUS-WORD (U)

The status word command allow access to information concerning various operating modes of the Model 706. The status word also contains information about the present status of the input and output lines on the digital I/O port. When the correct command is given, the Model 706 outputs the status word or I/O status the next time it is addressed to talk instead of sending its normal data string. Each byte in the status word is a number corresponding the previously programmed parameter with the following sequence:

706 ADEJKPTGMY

Refer to Figure 3-8 for an example of the status word.

To output the status word enter the following program into the HP-85.

PROGRAM	COMMENTS
10 REMOTE 718 (END LINE)	Programs the Model 706 into the remote mode.
20 CLEAR 7 (END LINE)	Clears the Model 706.
30 OUTPUT 718; "U4X" (END LINE)	Outputs status word.
40 ENTER 718; A\$ (END LINE)	Obtains data string.
50 DISP A\$ (END LINE)	Displays data string.
60 END (END LINE)	End of program.

Press the RUN key to implement the program. After pressing the RUN key the Model 706 outputs the status word. In this case the status word is transmitted to the controller with a prefix.

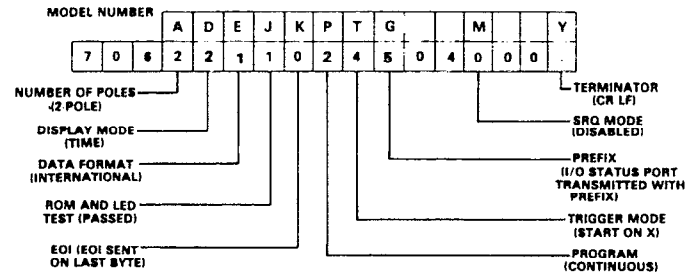

Figure 3-8. Status Word Format

#### NOTES

1. SRQ status information contains three bytes. These three bytes assume the decimal value previously set by the SRQ mode command.
2. To make sure proper status is returned, the status word should be read immediately after sending the command. Otherwise, instrument status may be changed from the front panel, resulting in erroneous status information.
3. The status word should not be confused with the SRQ status byte. The status word contains a number of bytes pertaining to the various operating modes of the instrument. The status byte is a single byte that is read by using the serial poll sequence and contains information on SRQ status and error or data conditions.

### 3.8 FRONT PANEL PROGRAMS

All the front panel programs described in paragraph 2.9, except Programs 3, 90, 91 and 92 can be controlled over the bus. For detailed examples and explanations of the front panel programs refer to paragraph 2.9.

### 3.9 FRONT PANEL ERROR MESSAGES

The process of programming the Model 706 involves the proper use of syntax. Syntax is defined as the orderly systematic arrangement of programming commands or languages. The Model 706 must receive valid commands with proper syntax or it will:

1. Ignore the entire command string in which the invalid command appears.
2. Set appropriate bits in the status byte.
3. Generate an SRQ if programmed to do so.
4. Display an appropriate front panel error message.

Device-dependent commands are sent as a string of several ASCII characters. Some examples of valid command strings include:

- F0X—Single command string.
- F0Q1B2X—Multiple command string.
- B1 X—Space is ignored.

Examples of invalid command strings are:

- @0X—Invalid command; @ is not a command.
- D6X—Invalid command option; 6 is not an option of the D command.

The numbers after the command are each interpreted as a decimal integer. For example:

- T01.0X—Interpreted as T1X.
- TX—Means T0X.

Figure 3-9 shows the front panel error messages used by the Model 706. The message in Figure 3-9(a) results from an illegal device-dependent command (IDDC), while the message in Figure 3-9(b) results from an illegal device-dependent command option (IDDCO). The no remote message in Figure 3-9(c) results from attempting to program the instrument when it is not in the remote mode.

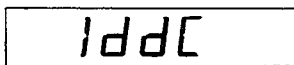

a. Illegal Device Dependent Command (IDDC)

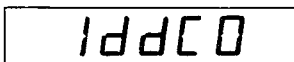

b. Illegal Device Dependent Command Option (IDDCO)

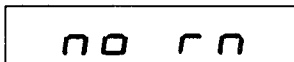

c. No Remote

Figure 3-9. IEEE Display Error Messages

#### 3.9.1 IDDC Error

An IDDC error results when the Model 706 receives an invalid command such as \$X. This command is invalid because no such letter exists in the instrument's programming language.

**Programming Example**—To demonstrate an IDDC error, enter the following statements into the HP-85 keyboard:

```
REMOTE 718 (END LINE)
OUTPUT 718; "$X" (END LINE)
```

When END LINE is pressed the second time, the error message in Figure 3-9a is displayed for about one second.

#### 3.9.2 No Remote Error

A front panel no remote error message will be displayed if the Model 706 is not in the remote mode when it receives a command over the bus. If an attempt is made to program the instrument when it is not in the remote mode, the no remote message in Figure 3-9c will be displayed on the front panel for about one second.

**Programming Example**—To make sure the instrument is not in the remote mode, enter the following statements into the HP-85:

```
LOCAL 7 (END LINE)
```

Now enter the following programming statement into the keyboard:

```
OUTPUT 718; "D1X" (END LINE)
```

When the statement is executed, the no remote error message in Figure 3-9c is displayed on the front panel of the instrument for about one second.

#### 3.9.3 IDDCO Error

An illegal device-dependent command option (IDDCO) results when the Model 706 receives an invalid command such as A7. This command option is invalid because no option of 7 exists for the command A.

**Programming Example**—To demonstrate an IDDCO error, enter the following statements into the HP-85 keyboard:

```
REMOTE 718 (END LINE)
OUTPUT 718; "A7X" (END LINE)
```

When the END LINE key is pressed the second time, the error message in Figure 3-9b is displayed for about one second.

### 3.10 SCANNING PROGRAM

The following program sets the Model 706 for the following parameters:

1. Sets programmed first channel to 1.
2. Sets programmed last channel to 100.
3. Sets the interval time to 200msec.
4. Sets the unit to the display mode.
5. Use the continuous scan mode.
6. Trigger the scan sequence on GET.
7. Provide a pause and clear statement.

Enter the following statements into the HP-85 to program the Model 706 to scan channels 1 through 100 at a 200msec interval rate.

<b>PROGRAM</b>	<b>COMMENTS</b>
10 REMOTE 718 (END LINE)	Model 706 set to remote.
20 CLEAR 7 (END LINE)	Clears Model 706.

30 OUTPUT 718; "DOF1L100W.2P2T2X" (END LINE)	Programs the Model 706 for the above parameters.
40 TRIGGER 718	Provides GET trigger.
50 PAUSE	Program pause.
60 CLEAR 7	Clears Model 706.
70 END	End of program.

To start the program, press the RUN key on the HP-85. After the RUN key is pressed the Model 706 scans the programmed channels at the programmed interval rate. To stop the program simply press the CONT key. The program will stop at the second channel when the CONT key is pressed. To resume the program press the CONT key a second time or press the RUN key. Upon pressing the RUN key or the CONT key (second time) the Model 706 continues the program.



## SECTION 4 THEORY OF OPERATION

### 4.1 INTRODUCTION

This section contains circuit descriptions of the Model 706. The information is arranged to provide a description of individual functional circuit blocks. To facilitate understanding, the descriptions are referenced to Figure 4-1, which is an overall block diagram of the Model 706. Detailed schematics of the Model 706 are located in Section 6.

### 4.2 POWER SUPPLY

To aid in understanding of the following discussion, refer to the block diagram in Figure 4-1.

The power supply is a 6V switching supply with 6A current capability. The AC input may range from 95V to 125V or 210V to 250V depending on internally selected jumpers. Refer to Section 5 Maintenance for complete details. The supply operates on line frequency from 47Hz to 440Hz. Regulation of the line and load is  $\pm 0.15\%$  with noise and ripple being a maximum of 5mV p-p.

The supply has an inherent solid state short circuit protection. An automatic current limiting circuit limits the output current which provides protection for the instrument as well as the supply. There is also a thermal circuit breaker to provide thermal overload protection.

### 4.3 MICROCOMPUTER

To simplify understanding of the following discussion refer to the block diagram in Figure 4-1 and schematic diagram 705-106 sheet 3 of 3.

The microcomputer includes a 6808 microprocessing unit (CPU) U105, a 6522 versatile interface adapter (VIA) U120, two 2764 ROMs, U106 and U107. The microcomputer also consists of two 6116s RAMs U108 and U109, an address decoder LS138 (U116), an asynchronous communication interface adapter (ACIA) U103 and assorted buffers and line drivers U104, U110, U118, U126, U122, U119, U111 and U112. The threshold detection and reset circuit consists of U115 and associated components. If the power supply voltage level drops below 4.5V for some reason, U115 resets the Model 706. The battery backup circuitry and clock circuitry consist of U121, U123, U124, U127, Q101, Q102, Y102 and associated components.

The IEEE-488 interface circuitry consists of a 9914 general purpose interface bus adapter U102, U101 and U113 are general purpose bus transceivers. The memory used in this system is

shown in the memory map Figure 4-2. Interfacing of the microprocessor with the RAMs, ROMs, Front Panel, VIA, ACIA or IEEE-488 interface circuitry is controlled by the address decoder, U116.

Partial address decoding is used in this system. The function selected is determined by the state of the A13, A14 and A15 address lines. These address lines determine which output is selected by the decoder U116 in accordance with the memory map. Only one of these device (ROM, RAM, VIA, ACIA, etc.) will have access to the data bus at any one time. The address decoder selects one of the devices only after a valid memory address (VMA) has been asserted at the decoders input G1 (pin 6). The VMA signal is generated by the 6808 microprocessor.

Timing for the computing sequences is provided by 4MHz crystals Y101. The 6808 microprocessor divides this signal by four to produce a 1MHz signal at the E (pin 37) output. This is a single phase TTL compatible clock. The clock may be conditioned by a memory read signal. This output is capable of driving one standard TTL load and 130pF.

U115 and its associated circuitry form a reset circuit which resets the microprocessor VIA, ACIA and IEEE-488 interface circuitry. The circuit actuates in the event the front panel display is not updated after a specific period of time (e.g. interval time) has elapsed due to a lost program or power line transient. The circuit also works as a threshold detector circuit.

As seen in schematic 705-106 sheet 3 of 3, the data lines running throughout the microcomputer circuitry are labeled as D0 through D7. The address lines running throughout the microcomputer circuitry are labeled as A0 through A15.

The serial out and alarm/serial in outputs are controlled by the ACIA (U103). R109 and R110 and CR103 comprise a protection network for these two outputs. The serial out output data is transmitted, via R110 and pin 6 of the ACIA (U103). The alarm/serial in data is transmitted/received via R109 and pin 2 of the ACIA. The external trigger input and channel ready output are controlled by the VIA, U120. R108, R111 and CR102 comprise a protection circuit for these two connectors, while R112 is a pull up resistor for the external trigger line. The external trigger input is routed into the circuitry via R111 and pin 40 of the VIA, U120. The channel ready output produces a TTL level negative going pulse of greater than 10 $\mu$ sec by way of R108 and pin 15 of the VIA when programmed to do so.

The control of the relay switching is accomplished by the parallel data on the data bus being buffered by U110 and sent





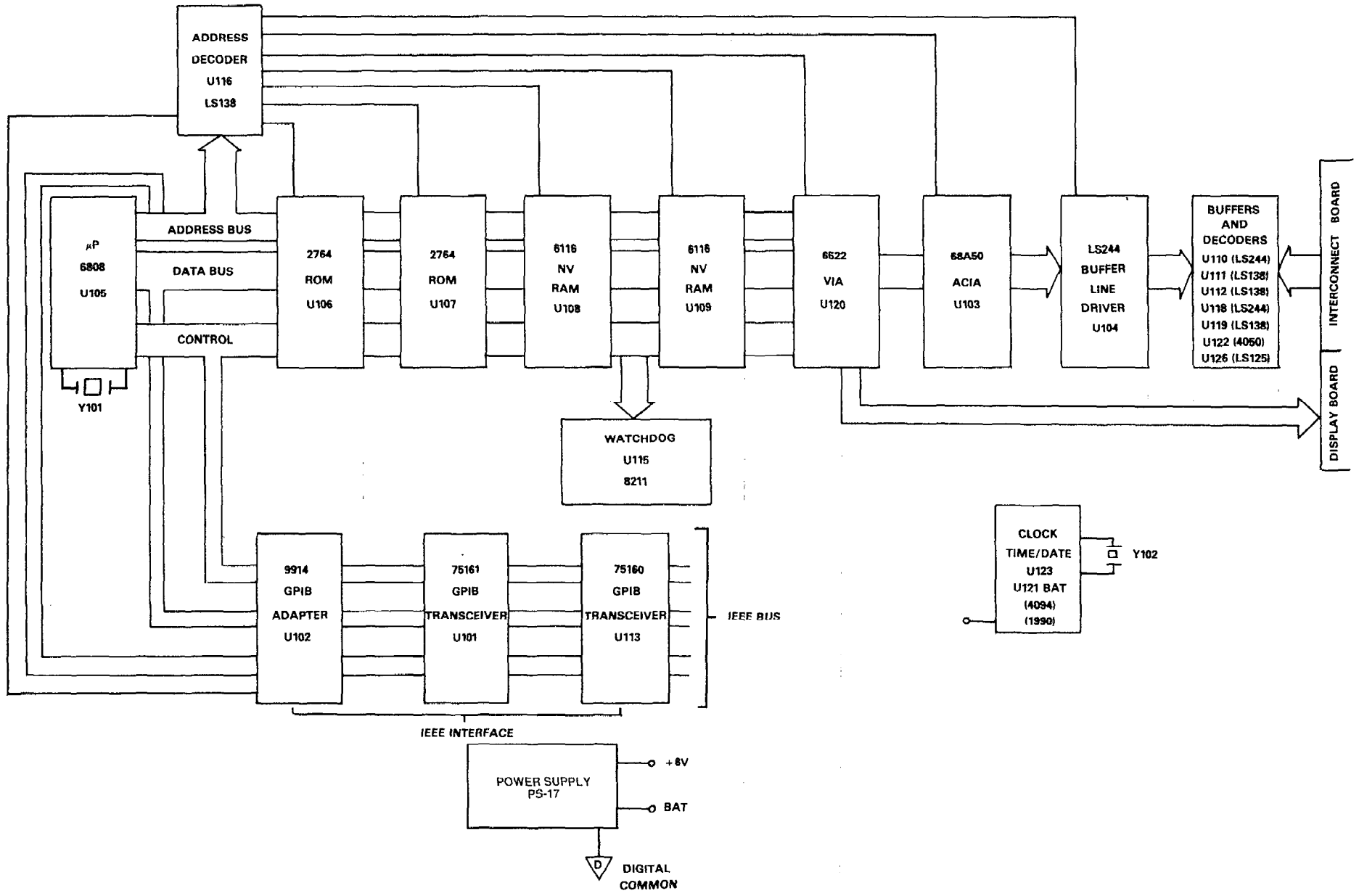

Figure 4-1. Model 706 Block Diagram

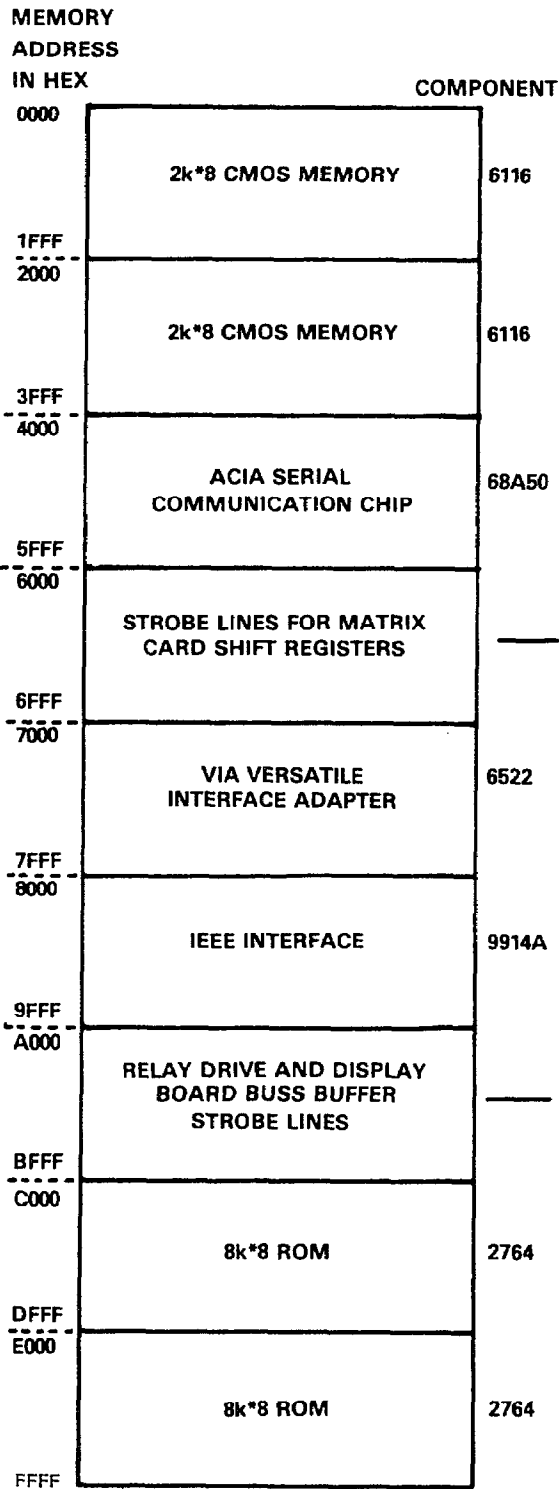

Figure 4-2. Model 706 Memory Map

to octal latches U421 through U438. The address lines A0 through A3 are buffered by U118 and that output is decoded by U111, U112 and U119. This information is the clock input for each octal latch. When the appropriate information arrives (pulse), the corresponding octal latch releases its data to the proper current drivers which in turn drive the relays on the cards. Pins 25 through 33 on connector J/P1020 transmits the buffered parallel data into the octal latches. Pins 3 through 20 are the individual clocks for each octal latch.

#### 4.4 DISPLAY CIRCUIT

The display data is routed from the VIA on PA0 through PA7 by way of connector P1010. The data is updated at a 1kHz rate which means each digit is on for 1msec. Each update begins by presenting new segment information on the VIA (I/O) bus (PA0/PA7) and yields a clock pulse on CA2. The clock pulse inputs to U203 and shifts a digit enable bit to be enabled. Every eight times the display is updated, a digit enable bit is generated at PB3 and is routed to the enable data input of the shift register.

The first four digit drivers drive the rows of the switch matrix. The switches are arranged in a four by six matrix. The segment drivers are Q201 through Q208. In addition to driving the various segments, they also activate the appropriate LEDs.

#### 4.5 IEEE-488 INTERFACE CIRCUITRY

The IEEE-488 interface circuitry is comprised of GPIB adapter U102, GPIB octal transceivers U101, U113 and associated capacitors. The standard bus connector (J1002) is located on the rear panel. The primary address is set from front panel Program 3. There are no primary address dip switches. Refer to paragraph 2.9.4 for complete details concerning the primary address.

GPIB adapter U102 is the heart of the IEEE-488 interface circuitry. U102 is capable of performing all IEEE-488 talk/listen protocols. The data bus consists of D0 through D7. The address lines that are routed to the IEEE-488 circuitry are A0, A1 and A2. The REN, IFC, NDAC, NRFD, DAV, EOI, ATN and SRQ lines are controlled by U102. Before the data is transmitted to the IEEE-488 bus via connector J1002, it is buffered by the octal bus transceivers U101 and U113. The REN, IFC, EOI (etc.) lines are buffered by U113. U101 and U113 operate on the tri-state output principle. That is, the output is either high, low or in a high impedance state.



## SECTION 5 MAINTENANCE

### 5.1 INTRODUCTION

This section contains information necessary to maintain the Model 706 scanner. The information in this section includes fuse replacement, line voltage selection, disassembly instructions and basic troubleshooting information.

### 5.2 FUSE REPLACEMENT

The Model 706 line fuse (F101) is located on the rear panel. F101 protects the line and the instrument in case of overload. If the line voltage setting is changed (see paragraph 5.3), the fuse must be replaced according to Tables 5-1 and 5-2. The fuse may be replaced by using the procedures described in the following paragraphs.

#### WARNING

**Disconnect the Model 706 from the power line and from other equipment before replacing the fuse.**

1. Turn power off and disconnect the line cord.
2. The fuse carrier is spring loaded. Using a flat blade screwdriver, push the fuse carrier in and rotate 1/4 turn counter-clockwise. The carrier and fuse will eject from the instrument.
3. Remove the fuse from the carrier and replace per Table 5-1 or Table 5-2.

#### CAUTION

**Do not install the fuse with a higher rating than specified in Table 5-1 or 5-2. Instrument damage may result.**

4. To install the fuse and carrier into the holder, reverse the procedure in step 2.

Table 5-1. Fuse Replacement 3AG Size

Line Voltage	Fuse (F101)	Keithley Part No.
90V-125V	1.25A, 250V SLO-BLO	FU-28
195V-250V	0.6A, 250V SLO-BLO	FU-27

Table 5-2. Fuse Replacement 5mm Size

Line Voltage	Fuse (F101)	Keithley Part No.
90V-125V	1.25A, 250V SLO-BLO	FU-58
195V-250V	0.6A, 250V SLO-BLO	FU-57

### 5.3 LINE VOLTAGE SELECTION

Set up the Model 706 to operate on the available AC line voltage as follows:

#### WARNING

**To prevent a shock hazard, always turn the instrument off and disconnect the line cord before removing the top or bottom cover.**

1. Remove the top cover. Refer to the disassembly instructions in paragraph 5.4. Refer to Figure 5-1.
2. Remove the power supply (PS-17) from the Model 706 mainframe. Refer to the disassembly instructions in paragraph 5.4 step 6.
3. Place the jumper across the appropriate pins as listed in Table 5-3. Also refer to Figure 5-2 for location of the jumpers.

#### NOTE

Table 5-3 and Figure 5-2 refer to a Xentek supply. Sheet 1 of the Mother Board schematic shows jumpers for a Lambda supply.

4. Install the proper fuse as stated in paragraph 5.2.

Line Voltage	Line Input	Jumper Placement
100V	1-5	1-3, 2-4
120V	1-4	1-3, 2-4
220V	1-5	2-3
240V	1-4	2-3



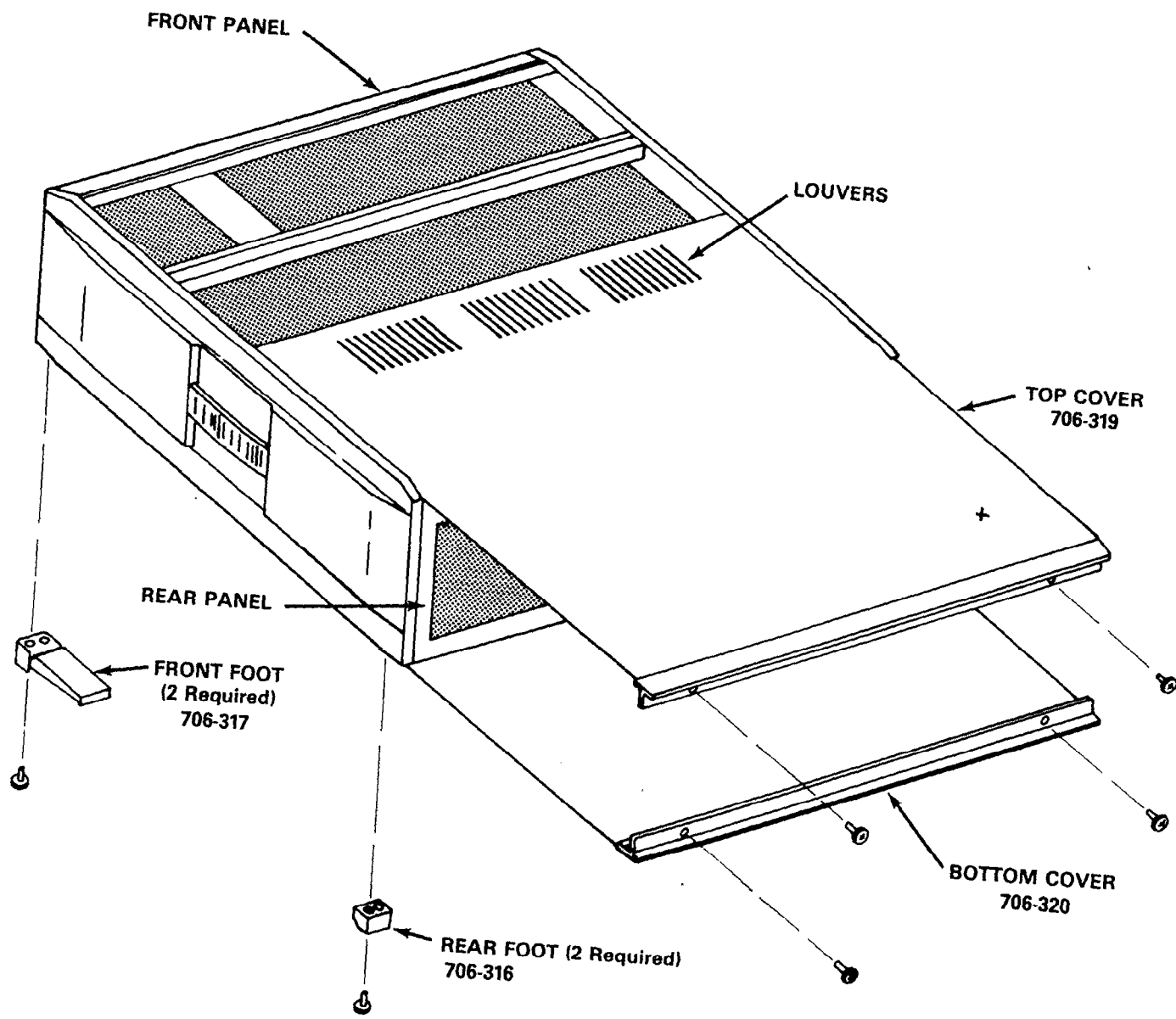

Figure 5-1. Top and Bottom Cover Removal



## 5.4 DISASSEMBLY

If it becomes necessary to disassemble the Model 706, use the following procedure. Also, refer to Figures 5-1, 5-2 and 5-3.

1. Remove the top cover as follows:

### WARNING

**To prevent a shock hazard, always turn the instrument off and disconnect the line cord before removing the top cover.**

- A. Remove the top two retaining screws located at the rear of the instrument.
- B. Grasping the top cover at the rear of the instrument, carefully pull it out and away from the instrument.
2. Remove the bottom cover in the same manner as the top cover with one exception. The four feet on the bottom cover must be removed in order to remove the bottom cover.
3. Remove the plug-in cards (see paragraph 2.2.2).
4. Remove digital I/O board as follows:
  - A. Remove the two screws that secure the digital I/O board to the mounting rail assembly (706-311).
  - B. Disconnect the digital I/O board from the mother board.
  - C. Lift the digital I/O board from the Model 706 mainframe.
5. Remove the four decorative strips from the side panels as follows:
  - A. From inside the mainframe, place a thin blade screwdriver into one of the holes where the decorative strip is secured. Refer to Figure 5-3.
  - B. Carefully push outwards from the mainframe with the screwdriver. The strip will disengage of one fastener and then can be pulled away from the mainframe.
  - C. Repeat steps A and B for the remaining decorative strips.
  - D. To install the decorative strip, align the strip in the recessed part of the side panel and press the strip at the points of the two fasteners. This action secures the strip in place.
6. Remove the power supply as follows:
  - A. Remove the three screws that secure the thermal breaker shield to the supply and mounting rail. Refer to Figure 5-3.
  - B. Remove the ground wire from the power supply.
  - C. Remove the two screws that secure the power supply to the side panel. Carefully lay the supply on top of the mounting rails.
  - D. Disconnect the Molex connectors for the AC input and DC output wires of the supply.
  - E. Remove the power supply from the mainframe.

- F. To install the supply, reverse the procedures of steps A through E.

### NOTE

When installing the power supply, make certain that the jumpers on the input terminals are configured for the available AC line voltage. Refer to paragraph 5.3.

7. Remove the mother board as follows:
  - A. Disconnect the cable that connects the mother board to the interconnect board (J/P 1020).
  - B. Disconnect the cable that connects the mother board to the IEEE connector (J/P 1011).
  - C. Disconnect the cable that connects the mother board to the digital I/O board (J/P 1009).
  - D. Disconnect the cable that connects the mother board to the display board (J/P 1010).
  - E. With the bottom panel removed turn the Model 706 upside down and remove the six screws that secure the mother board to the mainframe.
  - F. Remove the two power supply wires (+G) and (G) at the supply. Remove the wire that goes to the +G interconnect hole.
  - G. Remove the mother board.
  - H. To install the mother board, reverse the above procedure.
8. Remove the display board as follows:
  - A. Using a short Phillips screwdriver, remove the four screws that secure the display board to the front panel.
  - B. Remove the display board.
  - C. To install the display board reverse the procedures in steps A and B.
9. Remove the interconnect board as follows:

### NOTE

This procedure assumes that the mother board and the power supply are removed.

- A. Remove the three screws that secure the interconnect board to the bottom mounting rail.
- B. Remove the three screws that secure the interconnect board to the top mounting rail.
- C. Push the interconnect board towards the front panel and disconnect the 10 shields from the shield fasteners on the interconnect board.
- D. Lift the interconnect board out of the mainframe.
- E. To install the interconnect board reverse the procedure in steps A through D.
10. Remove the rear panel as follows:
  - A. Remove the four screws that secure the rear panel to the mainframe.
  - B. The ALARM/SERIAL IN, SERIAL OUT, EXT. TRIG-



GER, CHANNEL READY, LINE FUSE, Input Power Receptacle and IEEE-488 Interface connectors are still connected to their appropriate places in the main-frame. Be careful when removing the rear panel so as not to damage the connectors.

C. To install the rear panel: align the rear panel in place and install the four screws that secure it.

11. To reassemble the Model 706 reverse the procedures outlined in steps 1 through 10.

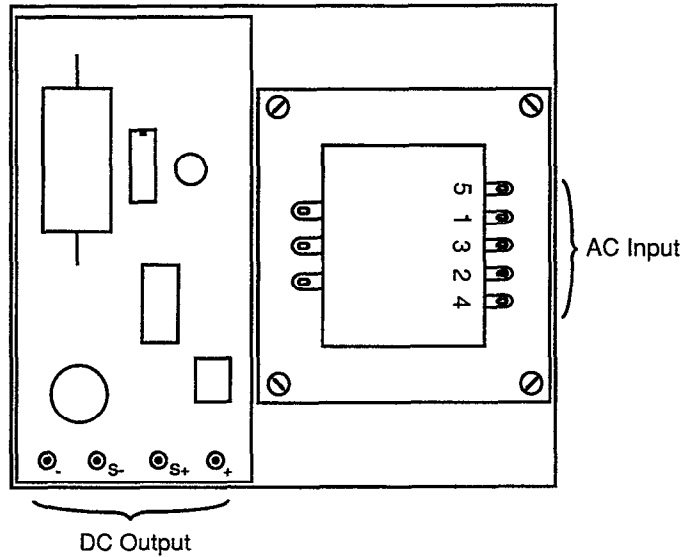

Figure 5-2. Power Supply Exploded View

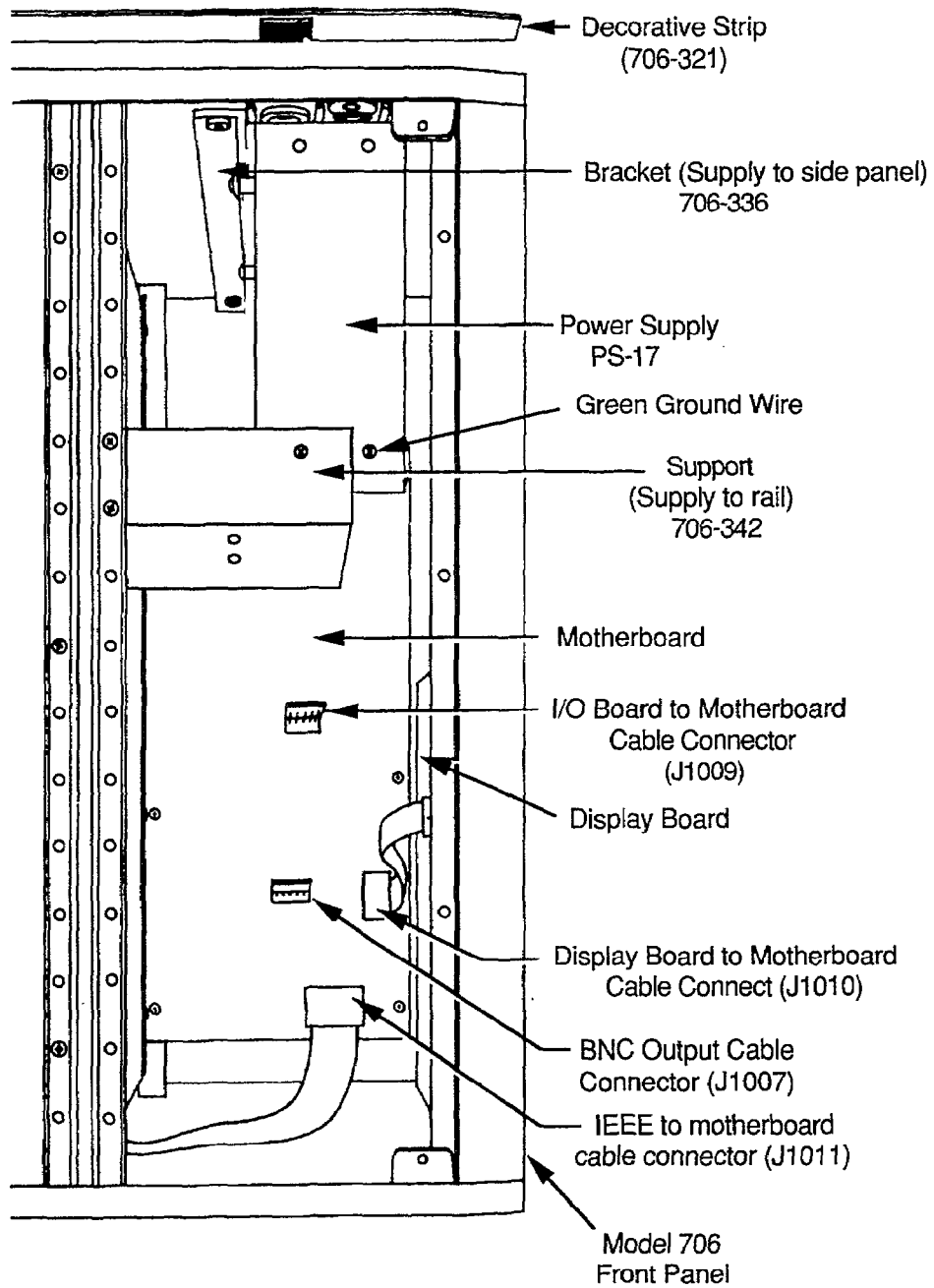

Figure 5-3. Model 706 Top View

## 5.5 TROUBLESHOOTING

The troubleshooting instructions contained in this section are intended for qualified personnel having a basic understanding of analog and digital circuitry. The individual should also be experienced at using typical electronic test equipment as well as ordinary troubleshooting procedures. The information presented here has been written to assist in isolating a defective circuit or circuit section; isolation of the specific component is left to the technician.

### 5.5.1 Recommended Test Equipment

The recommended test equipment to troubleshoot the Model 706 is listed in Table 5-4. The test equipment may vary but the specifications must be at least equal to the specifications listed in Table 5-4.

**Table 5-4. Recommended Test Equipment**

Equipment	Use
Five function DMM with 0.05% basic DC accuracy (Keithley Model 179A or equivalent)	Power supply and DC voltage checks, continuity, logic levels.
Dual trace, triggered-sweep oscilloscope, DC to 20MHz bandwidth	Waveform checks

### 5.5.2 Digital Self Test

Upon power-up the Model 706 performs a number of tests and displays several messages. These tests and messages are explained in paragraph 2.3. The Model 706, also upon power up, and upon activating Program 99 performs a digital self test on the RAM circuitry and a cyclic redundancy check (CRC) on the ROM circuitry. If the digital self test of the RAM circuitry reveals a problem the Model 706 displays the following:

1.A.A.A.A.A.A.

If the CRC reveals a problem the Model 706 displays the following:

1.0.0.0.0.0.

This display indicates that there is a problem with the Model 706's ROM circuitry. In either of these two cases, the Model 706's memory circuitry should be checked. The cause of the problem could be that a memory chip is loose in the socket.

Upon actuation of front panel Program 8 the Model 706 performs a digital self test and a CRC of the RAM and ROM circuitry respectively. If the digital self test reveals a problem with the RAM circuitry the Model 706 displays the following for approximately 0.5 seconds.

r A

After this display the Model 706 displays the following:

FAIL

If the CRC reveals a problem with the ROM circuitry the Model 706 displays the following for approximately 0.5 seconds.

r 0

After this display the Model 706 displays the following:

FAIL

If the self test and the CRC both reveal a problem, the Model 706 displays the RAM and ROM error messages and then displays the fails message.

When either test does not reveal a problem (using Program 8) the Model 706 displays the following message that indicates both tests have passed.

**Table 5-5. Power Supply Checks**

Step	Item/Component	Required Condition	Remarks
1	S101 Line Switch	Set line voltage as required.	See paragraph 5.3.
2	F101 Line Fuse	Continuity	Remove fuse to check.
3	J1001 Line Power	Plugged into line receptacle; power is on.	
4	AC input to supply. 2 pin Molex Connector	Line voltage (100, 120, 220, or 240V)	
5	+6V supply terminal +6V terminal referenced to the terminal.	+6V $\pm$ 5% (5.7V to 6.3V)	+6V supply



PASS

let it cool down for approximately one hour. Then turn the power back on. The thermal breaker should return to normal operation (which means the circuit is closed).

### 5.5.3 Power Supply Checks

If a problem exists in the Model 706, the power supply should be checked initially. The power supply checks are listed in Table 5-5. Use the DMM recommended in Table 5-4 to check the various test points. It is also a good idea to check each supply level with an oscilloscope to be sure there is little or no noise or ripple.

#### NOTE

The thermal breaker (TB-3) that is in series with the AC line and the power supply opens the circuit when the temperature inside the instrument reaches 65°C. This action shuts off the power to the instrument. In this case turn the Model 706 off and

### 5.5.4 Digital Circuitry Checks

Problems with the digital circuitry could cause erratic operation. Check the various components associated with the digital circuitry, including the IEEE interface, using the information in Table 5-6.

### 5.5.5 Display Board Checks

Check the display board per Table 5-7.

**Table 5-6. Digital Circuitry Checks**

Step	Item/Component	Required Condition	Remarks
1		Power On	Voltages referenced to digital common.  +5V digital supply. MPU HALT line. MPU NMI line. RESET line pin 40 remains LO for about 1 second after power on then goes HI. Also check for system clock on U103, U120, U102 and U118 pin 11. IRQ line.
2	U105 pin 8	+5V $\pm$ 5% (4.75V to 5.25V)	
3	U105 pin 2	+4V $\pm$ 20% (3.2V to 4.8V)	
4	U105 pin 6	+4V $\pm$ 20% (3.2V to 4.8V)	
5	U105 pin 40	Turn Model 706 off then on.	
6	U105 pin 37	1MHz Squarewave	
7	U120 pin 21	100 $\mu$ sec negative going pulses, variable intervals.	
8	U120 pins 2-9	0 to +4V, 2ms Pulses	Display and NVRAM data.

**Table 5-7. Display Board Checks**

Step	Item/Component	Required Condition	Remarks
1	Activate front panel PROGRAM 8.		Check to see that all LEDs are functional. Check that all annunciators are functional.
2	J/P1010 pins 9 and 14	+5V $\pm$ 5% (4.75V to 5.25V)	If LO, check per Table 5-5.
3	U203 pin 1		Update Data
4	U203 pin 8		Clock

### 5.5.6 Interconnect Board Checks

Check the interconnect board per Table 5-8.

### 5.6 BATTERY CHARGE

The battery backed up functions (Time, Date, Interval, etc.) are powered by BT101 and its associated circuitry when the Model 706 is turned off. The retention time of the battery backed up functions and data is typically one month with the unit turned off. To fully charge the battery it takes approximately two weeks (8 hours a day) of normal operation.

### 5.7 SPECIAL HANDLING OF STATIC SENSITIVE DEVICES

MOS devices are designed to function at high impedance levels. Normal static charge can destroy these devices. Table 5-9 lists all the static sensitive devices of the Model 706. Steps 1 through 7 provide instruction on how to avoid damaging these devices.

1. Devices should be handled and transported in protective containers, antistatic tubes or conductive foam.
2. Use a properly grounded work bench and a grounding wrist strap.
3. Handle devices by the body only.

4. PC boards must be grounded to bench while inserting devices.
5. Use antistatic solder removers.
6. Use grounded tip soldering irons.
7. After devices are soldered or inserted into sockets they are protected and normal handling can resume.

Table 5-9. Model 706 Static Sensitive Devices

Circuit Designation	Keihtley Part No.
U103	LSI-54
U105	LSI-27
U106	706-801-*
U107	706-800-*
U108	LSI-58
U109	LSI-58
U115	IC-177
U117	IC-149
U120	LSI-28
U121	IC-330
U122	IC-107
U123	IC-251
U124	IC-102
U127	IC-102
U301	IC-130
U303	IC-251
U421-U438	IC-339

Table 5-8. Interconnect Board Checks

Step	Item/Component	Required Conditions	Remarks
1	J1021 through J1030 pins 17 and 18 referenced to pins 5 and 6 (analog common).	+6V $\pm$ 4%	Interconnect board supply.
2		Program the Model 706 to scan channels 1 through 10 at a two second interval rate.	
3	U421 pin 2	+4V $\pm$ 1V	When the mainframe is scanning channel 1. Otherwise 0V.
4	U421 pin 5	+4V $\pm$ 1V	When the mainframe is scanning channel 2. Otherwise 0V.
5	U421 pin 6	+4V $\pm$ 1V	When the mainframe is scanning channel 3. Otherwise, 0V.
6	U421 pin 9	+4V $\pm$ 1V	When the mainframe is scanning channel 4. Otherwise, 0V.
7	U421 pin 12	+4V $\pm$ 1V	When the mainframe is scanning channel 5. Otherwise, 0V.
8	U421 pin 15	+4V $\pm$ 1V	When the mainframe is scanning channel 6. Otherwise, 0V.
9	U421 pin 16	+4V $\pm$ 1V	When the mainframe is scanning channel 7. Otherwise, 0V.
10	U421 pin 19	+4V $\pm$ 1V	When the mainframe is scanning channel 8. Otherwise, 0V.
11	U422 pin 2	+4V $\pm$ 1V	When the mainframe is scanning channel 9. Otherwise, 0V.
12	U422 pin 5	+4V $\pm$ 1V	When the mainframe is scanning channel 10. Otherwise, 0V.

**NOTE**

All the steps in Table 5-8 are referenced to Analog Common.

## SECTION 6 REPLACEABLE PARTS

### 6.1 INTRODUCTION

This section contains replacement parts information, schematic diagrams and component location drawings for the Model 706 scanner.

### 6.2 PARTS LIST

Parts are listed alpha-numerically in order of their circuit designations. Table 6-1 contains a list of the recommended spare parts. Table 6-2 contains an index of the schematic diagrams and component location drawings. Table 6-3 contains a parts list for the display board. Table 6-4 contains a parts list for the mother board. Table 6-5 contains a parts list for the digital I/O board. Table 6-6 contains a parts list for the interconnect board. Table 6-7 contains a mechanical parts list for the Model 706.

### 6.3 ORDERING INFORMATION

To place an order, or to obtain information concerning replacement parts, contact your Keithley representative or the factory. See the inside front cover for addresses. When ordering, include the following information.

1. Instrument Model Number.
2. Instrument Serial Number.
3. Part Description.
4. Circuit Description (if applicable)
5. Keithley Part Number

### 6.4 FACTORY SERVICE

If the instrument is to be returned to the factory for service, photostat and complete the copy of the service form which follows this section and return it with the instrument.

### 6.5 COMPONENT LOCATION DRAWINGS AND SCHEMATIC DIAGRAMS

Component location drawings and schematic diagrams follow the replaceable parts list in the order listed in Table 6-1.

**Table 6-2. Model 706 Index of Schematics and Component Layouts**

Figure	Title	Page
6-1	Display Board, Component Location Drawing	6-9
6-2	Digital I/O Board, Component Location Drawing	6-10
6-3	Mother Board, Component Location Drawing	6-11
6-4	Interconnect Board, Component Location Drawing	6-15
6-5	Display Board, Schematic Diagram	6-17
6-6	Digital I/O Board, Schematic Diagram	6-19
6-7	Mother Board, Schematic Diagram	6-21
6-8	Interconnect Board, Schematic Diagram	6-25

**Table 6-1. Model 706 Recommended Spare Parts List**

Keithley Part Number	Description	Qty
DD-30	"8" LED Display Digit	2
IC-107	Hex Buffer, 4050	2
IC-206	Darlington Transistor Array, ULN2003A	4
IC-339	Octal "D" type flip flops, 74C374	4
FU-28*	1.25A, 250V, SLO-BLO, 3AG for 90V-125V Operation	4
FU-27*	0.6A, 250V, SLO-BLO, 3AG for 195V-250V Operation	4
FU-58	1.25A, 250V, SLO-BLO, 5mm for 90V-125V Operation	
FU-57	0.6A, 250V, SLO-BLO, 5mm for 195V-250V Operation	
PL-67	LED Pilot Light	2
R-76-100	Resistor, 100Ω, 5%, ¼W, Composition	4
TF-141	Thick Film Resistor Network on the Digital I/O Board	2
LSI-27	Microprocessor, 6808	1
LSI-28	Versatile Interface Adapter, SY6522 (VIA)	1
LSI-54	Asynchronous Communication Interface Adapter (ACIA) 68A50	1

\*Either FU-28 or FU-27 is placed in the kit depending on the line voltage used.

Table 6-2. Display Board Parts List

Circuit Desig.	Description	Location		Keithley Part No.
		Sch	Pcb	
C201	10 $\mu$ F, 25V, Aluminum Electrolytic	D6	C3	C-314-10
C202	1000pF, 100V, Ceramic Disc	C5	C2	C-64-1000p
DS201	$\pm 1$ , LED Display Digit	B1	B2	DD-31
DS202	"8" LED Display Digit	C2	B2	DD-30
DS203	"8" LED Display Digit	C2	C2	DD-30
DS204	"8" LED Display Digit	D2	C2	DD-30
DS205	"8" LED Display Digit	D2	D2	DD-30
DS206	"8" LED Display Digit	E2	D2	DD-30
DS207	"8" LED Display Digit	E2	E2	DD-30
DS208	LED Pilot Light	G4	E1	PL-67
DS209	LED Pilot Light	G3	E2	PL-67
DS210	LED Pilot Light	F2	E2	PL-67
DS211	LED Pilot Light	G4	B2	PL-67
DS212	LED Pilot Light	G4	E2	PL-67
DS213	LED Pilot Light	G4	E2	PL-67
DS214	LED Pilot Light	G4	C3	PL-67
DS215	LED Pilot Light	H3	D3	PL-67
DS216	LED Pilot Light	G3	D3	PL-67
DS217	LED Pilot Light	H4	E3	PL-67
Q201	PNP, Silicon Transistor, 2N4355	F5	E1	TG-90
Q202	PNP, Silicon Transistor, 2N4355	H5	E1	TG-90
Q203	PNP, Silicon Transistor, 2N4355	H5	E1	TG-90
Q204	PNP, Silicon Transistor, 2N4355	H5	E1	TG-90
Q205	PNP, Silicon Transistor, 2N4355	F5	E2	TG-90
Q206	PNP, Silicon Transistor, 2N4355	G5	E2	TG-90
Q207	PNP, Silicon Transistor, 2N4355	G5	E2	TG-90
Q208	PNP, Silicon Transistor, 2N4355	G5	E2	TG-90
R201	Thick Film Resistor Network	SEV	D2	TF-165-1
R202	Thick Film Resistor Network	SEV	F1	TF-77
S201	Switch	A3	B2	SW-435
S202	Switch	B3	B2	SW-435
S203	Switch	B3	C2	SW-435
S204	Switch	A3	D2	SW-435
S205	Switch	A3	D2	SW-435
S206	Switch	B4	E2	SW-435
S207	Switch	B4	E2	SW-435
S208	Switch	A4	B3	SW-435
S209	Switch	A4	C3	SW-435
S210	Switch	B4	D3	SW-435
S211	Switch	B4	D3	SW-435
S212	Switch	A4	E3	SW-435
S213	Switch	A4	E3	SW-435
S214	Switch	B5	F2	SW-435
S215	Switch	B5	F2	SW-435
S216	Switch	A5	G2	SW-435
S217	Switch	A5	F2	SW-435
S218	Switch	A3	F2	SW-435
S219	Switch	B3	G2	SW-435
S220	Switch	B3	F3	SW-435
S221	Switch	A2	F3	SW-435
S222	Switch	A2	G3	SW-435

+

Table 6-2. Display Board Parts List (Cont.)

Circuit. Desig.	Description	Location Sch/Pcb	Keithley Part No.
S223	Switch	B2/F3	SW-435
S224	Switch	B2/F3	SW-435
S225	Switch	A2/G3	SW-435
U201	MOS to LED Segment Driver, 75392	SEV/B3	IC-169
U202	MOS to LED Segment Driver, 75492	SEV/G3	IC-169
U203	8-bit shift register, LS164	SEV/D3	IC-127
U204	MOS to LED Segment Driver, 75492	SEV/E3	IC-169
W201	Jumper	E1/D2	J-3
W202	Jumper	E1/D1	J-3

Table 6-3. Mother Board Parts List

Circuit. Desig.	Description	Location Sch/Pcb	Keithley Part No.
BT101	Battery, 3.6V, 100mAH Nicad	E4-1/E4 G4-2/B3	BA-36
C101	Capacitor, 0.1uF, 50V, Ceramic Film	C5-2/C3	C-237-.1
C102	Capacitor, 0.1uF, 50V, Ceramic Film	C6-2/C3	C-237-.1
C103	Capacitor, 0.1uF, 50V, Ceramic Film	B4-2/D3	C-237-.1
C104	Capacitor, 0.1uF, 50V, Ceramic Film	E2-1/E3	C-237-.1
C105	Capacitor, 10uF, 25V, Aluminum Electrolytic	D3-2/E3	C-314-10
C106	Capacitor, 0.1uF, 50V, Ceramic Film	E3-2 E3	C-237-.1
C107	Capacitor, 0.1uF, 50V, Ceramic Film	F3-2 F3	C-237-.1
C108	Capacitor, 0.1uF, 50V, Ceramic Film	A2-1/F3	C-237-.1
C109	Capacitor, 0.1uF, 50V, Ceramic Film	G6-2/B4	C-237-.1
C110	Capacitor, 0.1uF, 50V, Ceramic Film	G6-2/C3	C-237-.1
C111	Capacitor, 0.1uF, 50V, Ceramic Film	E5-2/C4	C-237-.1
C112	Capacitor, 0.1uF, 50V, Ceramic Film	E6-2/C5	C-237-.1
C113	Capacitor, 0.1uF, 50V, Ceramic Film	G1-2/C4	C-237-.1
C114	Capacitor, 0.1uF, 50V, Ceramic Film	A4-2/D4	C-237-.1
C115	Capacitor, 3ppF, 1000V, Ceramic Disc	A4-2/D4	C-64-33p
C116	Capacitor, 33pF, 1000V, Ceramic Disc	A1-2/D4	C-64-33p
C117	Capacitor, 0.1uF, 50V, Ceramic Film	E4-1/F4	C-237-.1
C118	Capacitor, 4.7uF, 25V, Aluminum Electrolytic	G5-1/F4	C-314-4.7
C119	Capacitor, 10pF, 1000V, Ceramic Disc	G4-1/F4	C-64-10p
C120	Capacitor, 22pF, 1000V, Ceramic Disc	F5-1/F4	C-64-22p
C121	Capacitor, 1000pF, 1000V, Ceramic Disc	E1-2/F3	C-64-1000p
C122	Capacitor, .1uF, 50V, Ceramic Film	G5-1/F4	C-237-.1
C123	Capacitor, .1uF, 50V, Ceramic Film	C6-1/G4	C-237-.1
C124	Capacitor, .1uF, 50V, Ceramic Film	E4-1/E4	C-237-.1
CR101	Diode, Silicon, 1N914	B3-2/D3	RF-28
CR102	Bridge Rectifier, VM18	D6-2/D4	RF-52
CR103	Bridge Rectifier, VM18	C6-2/D4	RF-52
CR104	Not Used		
CR105	Rectifier, Silicon, 1N4139	E3-1/D5	RF-34
CR106	Rectifier, Schottky Barrier, 1N5820	E3-1/D5	RF-53
CR107	Diode, Silicon, 1N914	E4-1/E4	RF-28
J1007	Connector, 5 pin molex	F6-2/C4	CS-288-5
J1009	Connector, 5 pin molex	H5-1/E4	CS-288-5
J1010	Socket (Display Board)	F6-2/C5	SO-65
J1011	Socket (IEEE Cable)	H6-2/B4	SO-68
J1020	Socket (Interconnect Board)	D1-1/G3	SO-84-40
	Power Supply	FG-1/—	PS-17

+

Table 6-3. Mother Board Parts List (Cont.)

Circuit Desig.	Description	Location		Keithley Part No.
		Sch	Pcb	
Q101	NPN, Silicon Transistor, 2N3904	E4-1	E4	TG-47
Q102	PNP, Silicon Transistor, 2N3906	E3-1	E4	TG-84
R101	Resistor, 3.3k, 5%, ¼W, Composition	G4-2	C3	R-76-3.3k
R102	Thick Film Resistor Network	SEV	C3	TF-99
R103	NOT USED			
R104	Resistor, 3.3k, 5%, ¼W, Composition	B3-2	D3	R-76-3.3k
R105	Resistor, 3.3k, 5%, ¼W, Composition	B3-2	D3	R-76-3.3k
R106	Resistor, 3.3k, 5%, ¼W, Composition	B3-2	D3	R-76-3.3k
R107	Resistor, 3.3k, 5%, ¼W, Composition	B2-2	D4	R-76-3.3k
R108	Resistor, 100Ω, 5%, ¼W, Composition	E6-2	D4	R-76-100
R109	Resistor, 100Ω, 5%, ¼W, Composition	D6-2	D4	R-76-100
R110	Resistor, 100Ω, 5%, ¼W, Composition	D6-2	D4	R-76-100
R111	Resistor, 100Ω, 5%, ¼W, Composition	D6-2	D4	R-76-100
R112	Resistor, 3.3k, ¼W, Composition	D6-2	D4	R-76-3.3k
R113	Resistor, 1k, 5%, ¼W, Composition	E4-1	E3	R-76-1k
R114	Resistor, 100k, 5%, ¼W, Composition	E1-2	E3	R-76-100k
R115	Resistor, 51k, 5%, ¼W, Composition	E2-1	E3	R-76-51k
R116	Resistor, 5.23k, 1%, 1/8W, Metal Film	D1-1	E3	R-88-5.23k
R117	Resistor, 88.7k, 1%, 1/8W, Metal Film	D2-1	E3	R-88-88.7k
R118	Resistor, 30k, 1%, 1/8W, Metal Film	D2-1	E3	R-88-30k
R119	Resistor, 10k, 5%, ¼W, Composition	F1-2	E3	R-76-10k
R120	Resistor, 100k, 5%, ¼W, Composition	F1-2	E4	R-76-100k
R121	Resistor, 10k, 5%, ¼W, Composition	F5-1	E4	R-76-10k
R122	Resistor, 150Ω, 5%, ¼W, Composition	E4-1	E4	R-76-150
R123	Resistor, 15k, 5%, ¼W, Composition	D4-1	E4	R-76-15k
R124	Resistor, 4.7k, 5%, ¼W, Composition	D4-1	E4	R-76-4.7k
R125	NOT USED			
R126	NOT USED			
R127	Resistor, 10k, 5%, ¼W, Composition	G5-1	F4	R-76-10k
R128	Resistor, 10k, 5%, ¼W, Composition	F5-1	F4	R-76-10k
R129	Resistor, 10k, 5%, ¼W, Composition	F4-1	F4	R-76-10k
R130	Resistor, 10k, 5%, ¼W, Composition	F4-1	F4	R-76-10k
S101	Line Switch	G2-1	—	SW-420
TK101	Thermal Breaker	G1-1	PS-17	TB-3
U101	GPIO Octal Transceiver, SN75161	G4-2	B2	IC-299
U102	GPIO Adapter, 9914	G5-2	B3	LSI-49
U103	Asynchronous Communications Interface Adapter, 68A50	D5-2	C2-	LSI-54
U104	Octal Buffer/Line Driver, 74LS244	C5-2	C3	IC-230
U105	Microprocessor, 6808	A2-2	D3	LSI-27
U106	EPROM, 2764	B2-2	D3	706-801-*
U107	EPROM, 2764	D3-2	E3	706-800-*
U108	CMOS RAM, HM6116	E2-2	E3	LSI-58
U109	CMOS RAM, HM6116	F2-2	F3	LSI-58
U110	Octal Buffer/Line Driver, 74LS244	A1-1	F2	IC-230
U111	Decoder/Demultiplexer, 74LS138	C4-1	G2	IC-182
U112	Decoder/Demultiplexer, 74LS138	C5-1	G2	IC-182
U113	GPIO Octal Tranceiver, SN75160	G5-2	B3	IC-298
U114	Quad 2-Input NAND, 74LS00	SEV	C3	IC-163
U115	Threshold Detector, ICL8211	E2-1	E3	IC-177
U116	Decoder/Demultiplexer, 74LS138	C1-1	F3	IC-182
U117	Quad Bi-lateral Switch, 4066	E1-2	F3	IC-149
U118	Octal Buffer/Line Driver, 74LS244	B3-1	F3	IC-230

\*Order same software as presently installed. For example, if A1 is displayed on power-up, order 706-801-A1 for U106.

**Table 6-3. Mother Board Parts List (Cont.)**

Circuit Desig.	Description	Location		Keithley Part No.
		Sch	Pcb	
U119	Decoder/Demultiplexer, 74LS138	C3-1	G3	IC-182
U120	Versatile Interface Adapter, SY6522	E5-2	C4	LSI-28
U121	Clock/Calendar, UPD 1990 AC	G5-2	F4	IC-330
U122	Hex Buffer, 4050	C6-1	G4	IC-107
U123	8 stage shift register, 14094	E5-1	F4	IC-251
U124	Quad 2-Input NAND, 4011	SEV	F4	IC-102
U125	Hex Inverter, 74LS04	SEV	F4	IC-186
U126	Buffer Gates, 74LS125	C6-2	F4	IC-336
U127	Quad 2-Input NAND, 4011	SEV	B4	IC-102
Y101	Crystal, 4MHz	A3-2	D3	CR-10
Y102	Crystal, 32.768kHz	G4-1	F4	CR-20

**NOTE**

The mother board schematic is spread out over two pages. The location of the components on which page is noted by the dash numbers in the location.

**Table 6-4. Digital I/O Board Parts List**

Circuit Desig.	Description	Location		Keithley Part No.
		Sch	Pcb	
C301	Capacitor, 0.1 $\mu$ F, 50V, Ceramic Disc	F2	D2	C-237-.1
C302	Capacitor, 0.1 $\mu$ F, 50V, Ceramic Disc	F2	D3	C-237-.1
C303	Capacitor, 0.1 $\mu$ F, 50V, Ceramic Disc	F3	D2	C-237-.1
CR301	Bridge Rectifier, VM18	E4	D3	RF-52
CR302	Bridge Rectifier, VM18	D4	D3	RF-52
CR303	Bridge Rectifier, VM18	E4	D3	RF-52
CR304	Bridge Rectifier, VM18	D4	E3	RF-52
Q301	NPN, Silicon Transistor, 2N3904	C3	E2	TG-47
R301	Thick Film Resistor, Network	SEV	C2	TF-90
R302	Thick Film Resistor Network	SEV	C2	TF-39
R303	Resistor, 68 $\Omega$ , 10%, 1/2W, Composition	F1	C2	R-1-68
R304	Thick Film Resistor Network	SEV	C3	TF-141
R305	Resistor, 2.2k, 5%, 1/4W, Composition	C3	E2	R-76-2.2k
R306	Resistor, 5.1k, 5%, 1/4W, Composition	C2	E2	R-76-5.1k
U301	8 stage shift register, 4021	E2	D2	IC-130
U302	Quad 2-Input NOR, 74LS02	SEV	D2	IC-179
U303	8 stage shift register, 14094	E3	E2	IC-251
U304	Hex Inverter, 74LS04	SEV	E2	IC-186
U305	Hex Inverter, 74LS04	SEV	E3	IC-186



Table 6-5. Interconnect Board Parts List

Circuit. Desig.	Description	Location Sch/Pcb	Keithley Part No.
C401	Capacitor, 10uF, 25V, Aluminum Electrolytic	C4-3/A2	C-314-10
C402	Capacitor, 0.1uF, 50V, Ceramic Film	D4-3/B3	C-237-.1
C403	Capacitor, 0.1uF, 50V, Ceramic Film	F4-3/C3	C-237-.1
C404	Capacitor, 0.1uF, 50V, Ceramic Film	G4-3/C3	C-237-.1
C405	Capacitor, 0.1uF, 50V, Ceramic Film	C4-3/D3	C-237-.1
C406	Capacitor, 0.1uF, 50V, Ceramic Film	D4-3/E3	C-237-.1
C407	Capacitor, 0.1uF, 50V, Ceramic Film	F4-2/E3	C-237-.1
C408	Capacitor, 0.1uF, 50V, Ceramic Film	G4-2/F3	C-237-.1
C409	Capacitor, 0.1uF, 50V, Ceramic Film	C4-1/G3	C-237-.1
C410	Capacitor, 0.1uF, 50V, Ceramic Film	E4-1/G3	C-237-.1
C411	Capacitor, 10uF, 25V, Aluminum Electrolytic	A4-3/A4	C-314-10
C412	Capacitor, 0.1uF, 50V, Ceramic Film	D2-3/A4	C-237-.1
C413	Capacitor, 0.1uF, 50V, Ceramic Film	F2-3/B4	C-237-.1
C414	Capacitor, 0.1uF, 50V, Ceramic Film	A2-2/C4	C-237-.1
C415	Capacitor, 0.1uF, 50V, Ceramic Film	C2-2/D4	C-237-.1
C416	Capacitor, 0.1uF, 50V, Ceramic Film	E2-2/E4	C-237-.1
C417	Capacitor, 0.1uF, 50V, Ceramic Film	F2-2/E4	C-237-.1
C418	Capacitor, 0.1uF, 50V, Ceramic Film	B2-1/F4	C-237-.1
C419	Capacitor, 0.1uF, 50V, Ceramic Film	D2-1/G4	C-237-.1
C420	Capacitor, 0.1uF, 50V, Ceramic Film	B2-3/G4	C-237-.1
C421	Capacitor, 0.1uF, 500V, Ceramic Disc	A4-3/A2	C-237-.01
J1021	Card Edge Connector	D5-3/B2	CS-454-2
J1022	Card Edge Connector	E5-5/B2	CS-454-2
J1023	Card Edge Connector	G5-3/C2	CS-454-2
J1024	Card Edge Connector	A6-2/D2	CS-454-2
J1025	Card Edge Connector	C6-2/D2	CS-454-2
J1026	Card Edge Connector	D6-2/E2	CS-454-2
J1027	Card Edge Connector	F6-2/F2	CS-454-2
J1028	Card Edge Connector	H6-2/F2	CS-454-2
J1029	Card Edge Connector	B6-1/G2	CS-454-2
J1030	Card Edge Connector	D6-1/H2	CS-454-2
R401	Resistor, 220K, 5%, 1/4W, Composition	A4-3/A2	R-76-220K
U401	Darlington Transistor Array, ULN2003	E4-3/B2	IC-206
U402	Darlington Transistor Array, ULN2003	F2-3/C2	IC-206
U403	Darlington Transistor Array, ULN2003	B4-2/C2	IC-206
U404	Darlington Transistor Array, ULN2003	C4-2/D2	IC-206
U405	Darlington Transistor Array, ULN2003	E4-2/D2	IC-206
U406	Darlington Transistor Array, ULN2003	F4-2/E2	IC-206
U407	Darlington Transistor Array, ULN2003	B4-1/F2	IC-206
U408	Darlington Transistor Array, ULN2003	C4-1/G2	IC-206
U409	Darlington Transistor Array, ULN2003	E3-1/G2	IC-206
U410	Not Used		
U411	Darlington Transistor Array, ULN2003	D4-3/B3	IC-206
U412	Darlington Transistor Array, ULN2003	E4-3/C3	IC-206
U413	Darlington Transistor Array, ULN2003	G4-3/C3	IC-206
U414	Darlington Transistor Array, ULN2003	C4-2/D3	IC-206
U415	Darlington Transistor Array, ULN2003	D4-2/E3	IC-206
U416	Darlington Transistor Array, ULN2003	E4-2/E3	IC-206
U417	Darlington Transistor Array, ULN2003	G4-2/F3	IC-206
U418	Darlington Transistor Array, ULN2003	C4-1/G3	IC-206
U419	Darlington Transistor Array, ULN2003	D4-1/G3	IC-206
U420	Not Used		
U421	Octal "D" Type Flip Flop, 74C374	D2-3/A4	IC-339
U422	Octal "D" Type Flip Flop, 74C374	E2-3/B4	IC-339
U423	Octal "D" Type Flip Flop, 74C374	F2-3/B4	IC-339





**Table 6-5. Interconnect Board Parts List**

<b>Circuit. Desig.</b>	<b>Description</b>	<b>Location Sch/Pcb</b>	<b>Keithley Part No.</b>
U424	Octal "D" Type Flip Flop, 74C374	G2-3/C4	IC-339
U425	Octal "D" Type Flip Flop, 74C374	B2-2/C4	IC-339
U426	Octal "D" Type Flip Flop, 74C374	B2-2/D4	IC-339
U427	Octal "D" Type Flip Flop, 74C374	C2-2/D4	IC-339
U428	Octal "D" Type Flip Flop, 74C374	D2-2/D4	IC-339
U429	Octal "D" Type Flip Flop, 74C374	E2-2/E4	IC-339
U430	Octal "D" Type Flip Flop, 74C374	F2-2/E4	IC-339
U431	Octal "D" Type Flip Flop, 74C374	G2-2/E4	IC-339
U432	Octal "D" Type Flip Flop, 74C374	B2-1/F4	IC-339
U433	Octal "D" Type Flip Flop, 74C374	B2-1/F4	IC-339
U434	Octal "D" Type Flip Flop, 74C374	C2-1/F4	IC-339
U435	Octal "D" Type Flip Flop, 74C374	D2-1/G4	IC-339
U436	Octal "D" Type Flip Flop, 74C374	C2-3/G4	IC-339
U437	Octal "D" Type Flip Flop, 74C374	B2-3/G4	IC-339
U438		A2-3/H4	

**NOTE**

The interconnect board schematic consists of three pages. The location of the components on which page is noted by the dash numbers in the location schematic column.

**Table 6-6. Model 706 Mechanical Parts List**

<b>Description</b>	<b>Qty.</b>	<b>Keithley Part No.</b>
Side Panel Assembly	2	706-301
Front Bezel Assembly	1	706-303
Front Bezel Assembly (Modified)	1	706-304
Front Panel (contains a and b)	1	706-305
a. #2-56-1/4 Long Pem stud	2	
b. #4-40 x 7/16 long clinch standoff	4	
Standoff	2	ST-155-1
Front Panel Overlay	1	706-307
AC Line Switch (S101)	1	SW-420
Pushbutton, Red	1	29465-3
Connector, Plug	1	CS-325-2
Connector, Pin	2	CS-246
Cable Assembly, Display Board (P1010)	1	CA-15-2
Pushbutton, Yellow Brown	1	31470-4
Pushbutton, Light Brown	6	31470-5
Pushbutton, Brown	6	31470-6
Pushbutton, Dark Brown	12	31470-7
Cable Assembly, IEEE (P1011)	1	
a. Connector (J1002)	1	CS-467
b. Cable	1	CA-21-1
Fuse Holder, Body	1	FH-24
Fuse Carrier	1	
a. 5mm size		FH-26
b. 3AG size		FH-25
Line Filter (J1001)	1	LF-2
Connector, Receptacle (J1018)	1	CS-326-2
Connector, Pin	2	CS-245
Mounting Hardware, IEEE	1	CS-378
Rear Panel Assembly	1	706-309
BNC Connector (J1003-J1006)	4	CS-249



**Table 6-6. Model 706 Mechanical Parts List (Cont.)**

Description	Qty.	Keithley Part No.
Connector, Receptacle (J1013 to PS-17)	1	CS-326-2
Connector	2	CS-245
Connector, Plug (P1015)	1	CS-325-4
Connector (to P1015)	2	CS-246
Connector, Receptacle (J1015)	1	CS-326-4
Connector (to J1015)	4	CS-245
Connector (P1007)	1	CS-287-5
Connector	5	CS-276
Grommet (Insulates I/O Board from case)	2	28479-5
Mounting Rail Assembly	4	706-311
Card Guide	4	706-315
Interconnect Board/Mounting Rail Assembly		
a. Mounting Rail Assembly	2	706-311
b. Board Support Bracket	2	706-314
Interconnect Bracket to Mounting Rail Screws		
#6-32-5/16 long Phillips Pan Head Screw	6	
Interconnect Board Cable Assembly (P1020)	1	CA-20-1
Interconnect Board Connector (J1021 through J1030)	10	CS-454-2
Fastener, Scanner Card Shields	10	FA-99
Shield	10	706-312
Mother Board to Mounting Rail and Front Bezel screws		
#6-32 x 1/4 Long Phillips Pan Head Screws	6	
Mounting Rails to Side Panels Screws		
#10-32 x 3/8 long Phillips Pan Head Screws	12	
Socket, Display Board (J1010)	1	SO-65
Socket, IEEE cable (J1011)	1	SO-68
Socket, Interconnect Board (J1020)	1	SO-84-40
Socket, U106 and U107	2	SO-69
Contact, I/O Board (P1009)	5	CS-276
Connector, I/O Board	1	CS-287-5
Bracket, I/O Board	1	706-323
a. Pem Nut, #6-32	2	
b. Standoff, #6-32	2	
I/O Board to I/O Bracket Screws	2	
#4-40 x 1/4 Phillips Pan Head Screw		
I/O Board to Mounting Rail Screw	2	
#6-32 x 1/4 long Phillips Pan Head Screw		
Bracket, Power Supply to side panel	1	706-336
Cable Clamp	2	CC-18
Power Supply Bracket to Side Panel Screws		
#10-32 x 3/8 long Phillips Pan Head Screw	2	
Support, Power Supply to mounting rail	1	706-342
Spacers, Power Supply to bracket	2	ST-177-1
Rear Bezel	2	706-313
Top Cover	1	706-319
Bottom Cover	1	706-320
Rear Foot	2	706-316
Front Foot	2	706-317
Decorative Strip Assembly	4	706-321
Line Cord (P1001)	1	CO-7
Line Cord (European)	1	CO-26
Card Edge Connector	1	CS-444-2
Label for Rear Bezel Bottom	1	MS-343



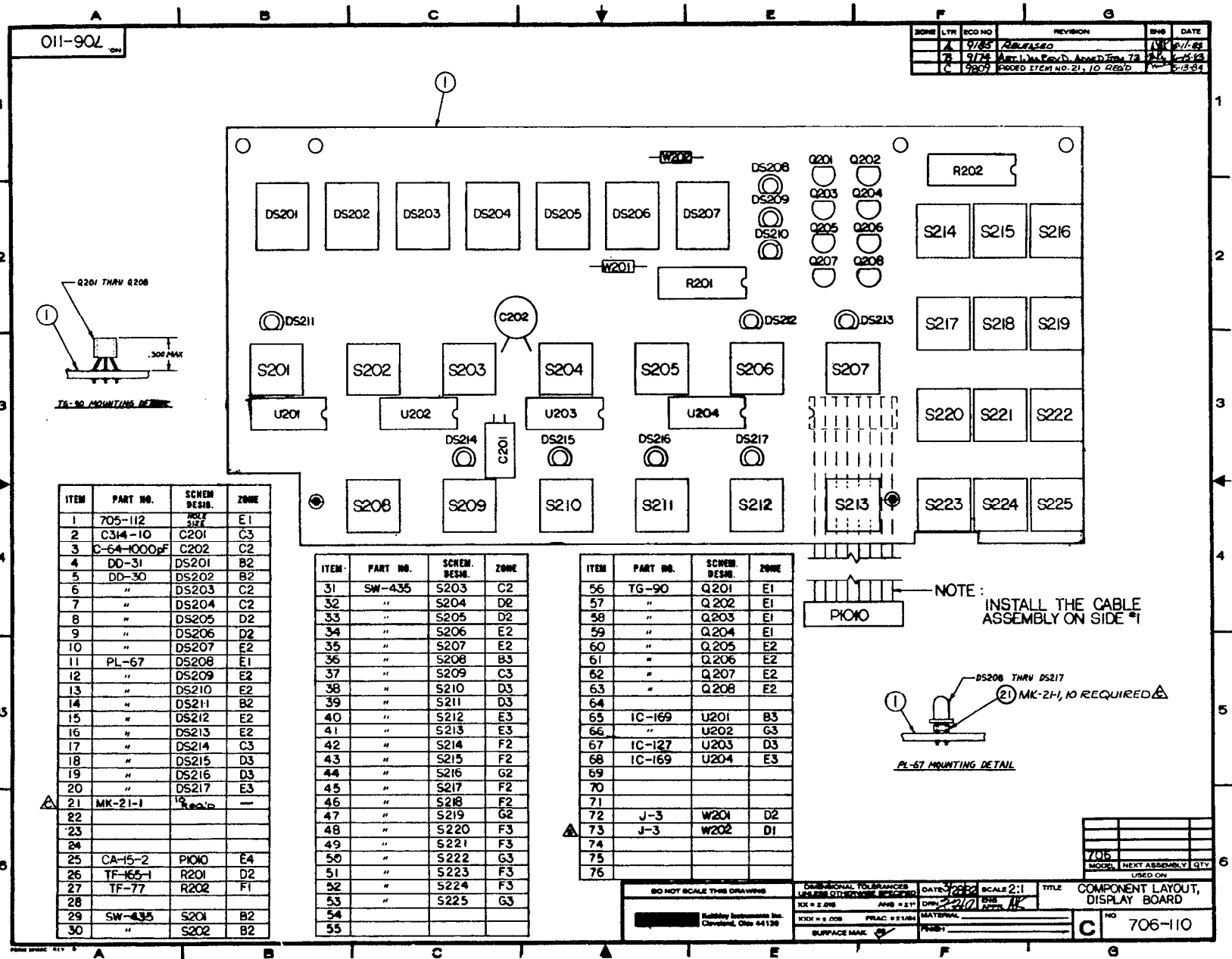

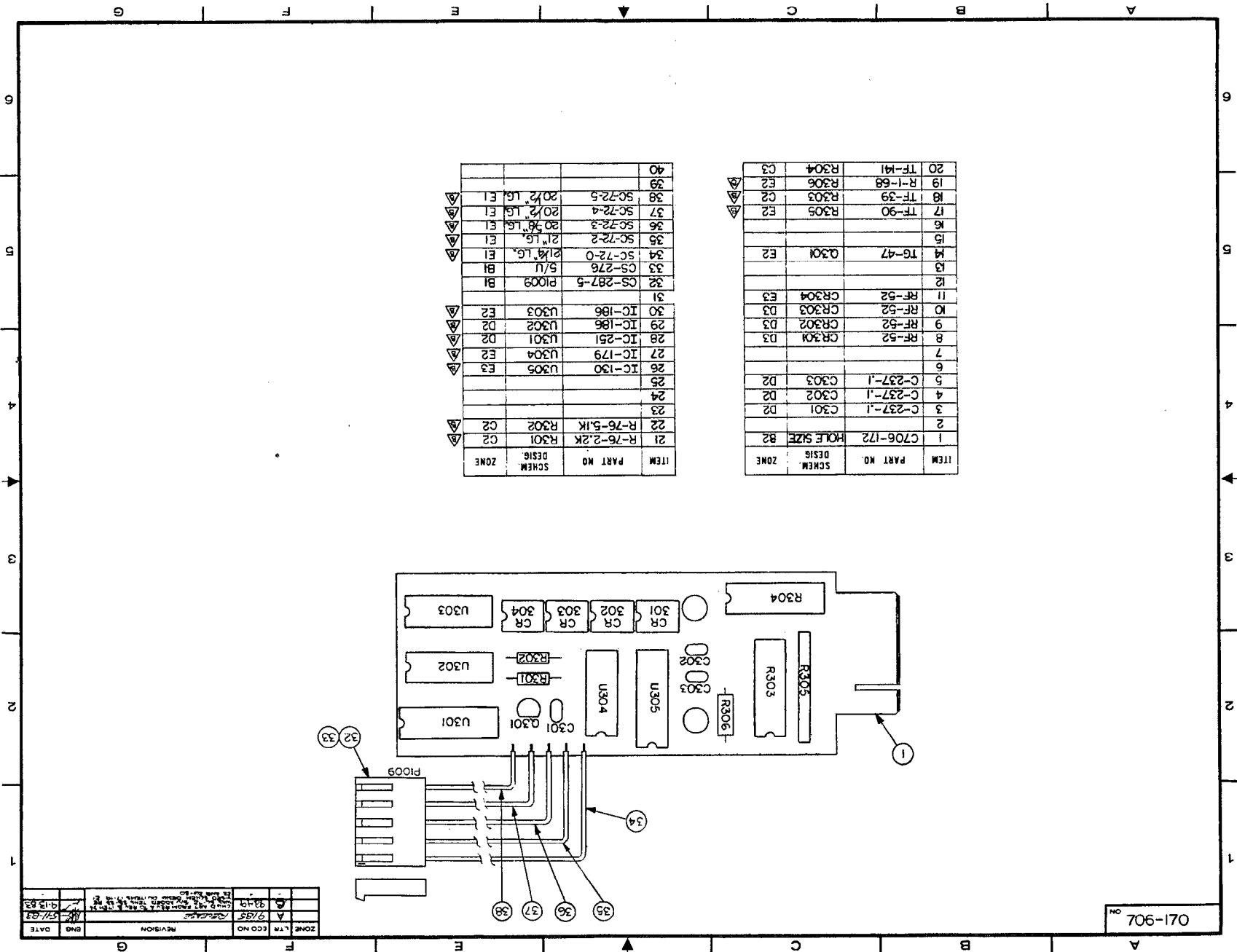
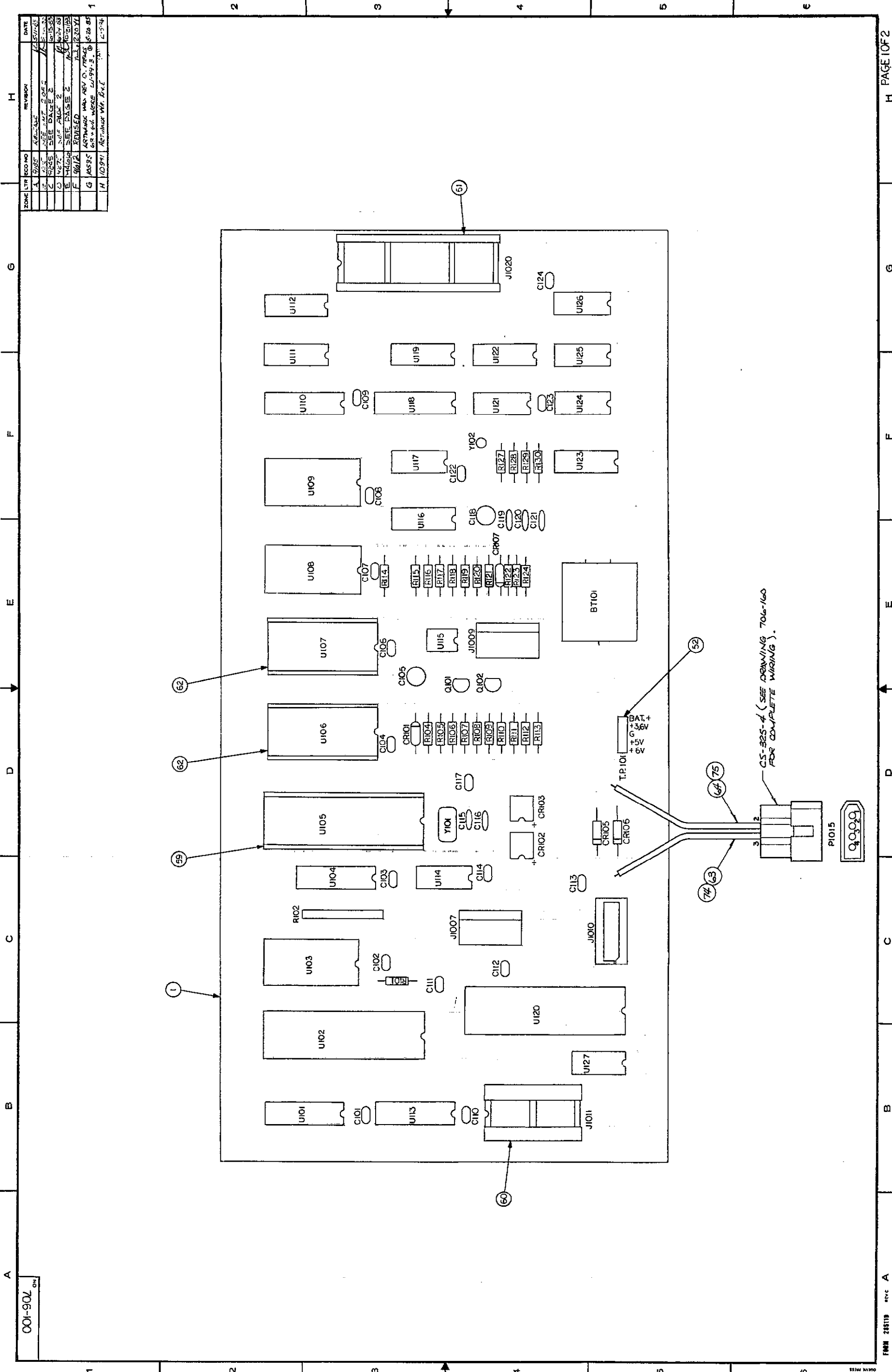

Figure 6-2. Digital I/O Board, Component Location Drawing, Dwg. No. 706-170



ZONE	LTR	ECO	NO	REVISION	DATE
A	203C	46-2AS		REVISED	12-5-74
B	203C	46-2AS		REVISED	12-5-74
C	203C	46-2AS		REVISED	12-5-74
D	203C	46-2AS		REVISED	12-5-74
E	203C	46-2AS		REVISED	12-5-74
F	203C	46-2AS		REVISED	12-5-74
G	203C	46-2AS		REVISED	12-5-74
H	203C	46-2AS		REVISED	12-5-74

ZONE	LTR	ECO	NO	REVISION	DATE
A	203C	46-2AS		REVISED	12-5-74
B	203C	46-2AS		REVISED	12-5-74
C	203C	46-2AS		REVISED	12-5-74
D	203C	46-2AS		REVISED	12-5-74
E	203C	46-2AS		REVISED	12-5-74
F	203C	46-2AS		REVISED	12-5-74
G	203C	46-2AS		REVISED	12-5-74
H	203C	46-2AS		REVISED	12-5-74

Figure 6-3. Mother Board, Component Location  
 Drawing, Dwg. No. 706-100 (sheet 1 of 2)  
 6-11/6-12

001-90Z ON

ZONE	LTR	ECO NO	REVISION	DATE
A	4/85		RELEASE	11/5/85
B	9/85		ITEM 19 WAS C-237.1	11/5/85
C	10/85		ITEMS 22, 23, 24 WERE C-100, 300, 400 ITEM 24 WAS U-100	11/5/85
D	9/85		ITEM 19 WAS C-237.1	11/5/85
E	9/85		ADDED ITEM 47 CR107 (RF-25)	11/5/85
F	9/85		SEE PAGE 1.	11/5/85
G	10/85		SEE PAGE 1.	11/5/85
H	10/91		See Page 1	11/5/85

ITEM	PART NO.	SCHEM. DESIG.	ZONE
1	706-101	SPACING	C2
2	BA-36	BT101	E4
3			
4	C-237-1	C101	B3
5	"	C102	C3
6	"	C103	C3
7	"	C104	D3
8	C-34-10	C105	D3
9	C-237-1	C106	E3
10	"	C107	E3
11	"	C108	F3
12	"	C109	F3
13	"	C110	B4
14	"	C111	C3
15	"	C112	C4
16	"	C113	C4
17	C-237-1	C114	C4
18	C64-33PF	C115	D4
19	C64-33PF	C116	D4
20	C-237-1	C117	D4
21	C314-47	C118	F4
22	C64-10PF	C119	F4
23	C64-22PF	C120	F4
24	C64-1000PF	C121	F4
25	C-237-1	C122	F4
26	"	C123	F4
27	"	C124	G4
28			
29			
30			
31			
32			
33			
34			
35			
36			
37			
38			
39			
40			

ITEM	PART NO.	SCHEM. DESIG.	ZONE
41	RF-28	CR101	D3
42	RF-52	CR102	D4
43	"	CR103	D4
44	Not Used		
45	RF-34	CR105	D5
46	RF-53	CR106	D5
47	RF-23	CR107	E4
48			
49			
50	CS-288-5	J1007	C4
51	CS-288-5	J1009	E4
52	CS-339-5	TP101	D5
53			
54			
55			
56	SD-65	J1010	D5
57			
58			
59	SD-84-40	114	D2
60	SD-68	J1011	B4
61	SD-84-90	J1020	E3
62	SD-69	214	D2
63	CS-246	—	D6
64	CS-246	—	D6
65	T6-47	Q101	E4
66	T6-84	Q102	E4
67			
68			
69			
70			
71			
72			
73			
74	SC-71-6	114	C5
75	SC-71-1	141	D5
76			
77			
78			
79			
80			

ITEM	PART NO.	SCHEM. DESIG.	ZONE
81	R76-33K	R101	C3
82	7F-99	R102	C2
83	NOT USED		
84	R76-33K	R104	D3
85	"	R105	D3
86	"	R106	D4
87	"	R107	D4
88	R76-100	R108	"
89	"	R109	"
90	"	R110	"
91	R76-100	R111	"
92	R76-33K	R112	"
93	R76-1K	R113	"
94	R76-100K	R114	E3
95	R76-51K	R115	"
96	R88-523K	R116	"
97	R88-887K	R117	"
98	R88-30K	R118	"
99	R76-70K	R119	E4
100	R76-100K	R120	"
101	R76-10K	R121	"
102	R76-150	R122	"
103	R76-15K	R123	"
104	R76-4.7K	R124	E4
105	NOT USED		
106	NOT USED		
107	R76-10K	R127	F4
108	"	R128	F4
109	"	R129	F4
110	"	R130	F4
111			
112			
113			
114			
115			
116			
117			
118			
119			
120			

ITEM	PART NO.	SCHEM. DESIG.	ZONE
121	IC-299	U101	B2
122	LSI-49	U102	B2
123	LSI-54	U103	C2
124	IC-230	U104	C2
125	LSI-27	U105	D2
126	706-801	U106	D2
127	706-800	U107	E2
128	LSI-58	U108	"
129	LSI-58	U109	F2
130	IC-230	U110	F2
131	IC-182	U111	F2
132	"	U112	G2
133	IC-298	U113	E3
134	IC-163	U114	C3
135	IC-177	U115	E3
136	IC-182	U116	E3
137	IC-149	U117	F3
138	IC-230	U118	F3
139	IC-182	U119	F3
140	LSI-28	U120	C4
141	IC-330	U121	F4
142	IC-107	U122	F4
143	IC-251	U123	F4
144	IC-102	U124	F4
145	IC-186	U125	F4
146	IC-336	U126	F4
147	IC-102	U127	B4
148			
149			
150	CR-10	Y101	D3
151	CR-20	Y102	F4
152			
153			
154			
155			
156			
157			
158			
159			
160			

Figure 6-3. Mother Board, Component Location Drawing, Dwg. No. 706-100 (sheet 2 of 2)

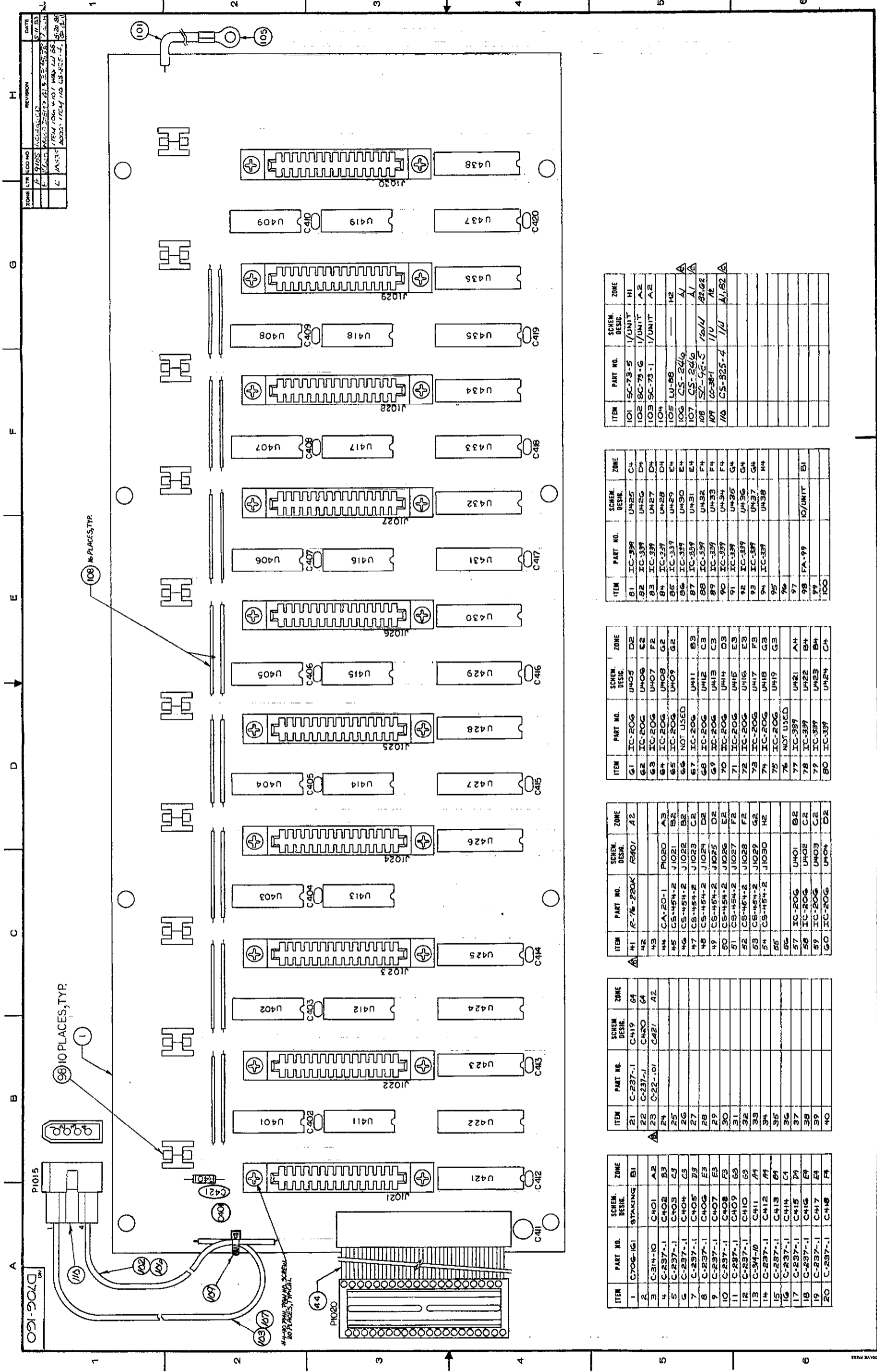

ZONE	LT#	ECO NO	REVISION	DATE
A	9/25	1	1	5/11/83
B	9/25	1	1	5/11/83
C	9/25	1	1	5/11/83
D	9/25	1	1	5/11/83
E	9/25	1	1	5/11/83
F	9/25	1	1	5/11/83

ITEM	PART NO.	SCHEM. DESIG.	ZONE
101	SC-73-5	1/UNIT	H1
102	SC-73-6	1/UNIT	A2
103	SC-73-1	1/UNIT	A2
104			
105	LU-88		H2
106	CS-246		A1
107	CS-246		A1
108	SC-525-5	10/1	B1, B2
109	CS-38-1	1/1	A2
110	CS-325-4	1/1	A1, B2

ITEM	PART NO.	SCHEM. DESIG.	ZONE
81	IC-389	UH25	C4
82	IC-389	UH26	C4
83	IC-389	UH27	D4
84	IC-389	UH28	D4
85	IC-389	UH29	E4
86	IC-389	UH30	E4
87	IC-389	UH31	E4
88	IC-389	UH32	F4
89	IC-389	UH33	F4
90	IC-389	UH34	F4
91	IC-389	UH35	G4
92	IC-389	UH36	G4
93	IC-389	UH37	H4
94	IC-389	UH38	H4
95			
96			
97			
98	FA-99	10/UNIT	B1
99			
100			

ITEM	PART NO.	SCHEM. DESIG.	ZONE
61	IC-206	UH05	D2
62	IC-206	UH06	E2
63	IC-206	UH07	F2
64	IC-206	UH08	G2
65	IC-206	UH09	G2
66	NOT USED		
67	IC-206	UH11	B3
68	IC-206	UH12	C3
69	IC-206	UH13	C3
70	IC-206	UH14	D3
71	IC-206	UH15	E3
72	IC-206	UH16	E3
73	IC-206	UH17	F3
74	IC-206	UH18	G3
75	IC-206	UH19	G3
76	NOT USED		
77	IC-389	UH21	A4
78	IC-389	UH22	B4
79	IC-389	UH23	B4
80	IC-389	UH24	C4

ITEM	PART NO.	SCHEM. DESIG.	ZONE
41	R-76-220K	R401	A2
42			
43	CA-20-1	P1020	A3
44	CS-454-2	J1021	B2
45	CS-454-2	J1022	B2
46	CS-454-2	J1023	C2
47	CS-454-2	J1024	D2
48	CS-454-2	J1025	D2
49	CS-454-2	J1026	E2
50	CS-454-2	J1027	F2
51	CS-454-2	J1028	F2
52	CS-454-2	J1029	G2
53	CS-454-2	J1030	H2
54	CS-454-2		
55			
56			
57	IC-206	UH01	B2
58	IC-206	UH02	C2
59	IC-206	UH03	C2
60	IC-206	UH04	D2

ITEM	PART NO.	SCHEM. DESIG.	ZONE
21	C-237-1	C419	G4
22	C-237-1	C420	G4
23	C-22-01	C421	A2
24			
25			
26			
27			
28			
29			
30			
31			
32			
33			
34			
35			
36			
37			
38			
39			
40			

ITEM	PART NO.	SCHEM. DESIG.	ZONE
1	C706-161	STAKING	B1
2			
3	C-314-10	CH01	A2
4	C-237-1	CH02	B3
5	C-237-1	CH03	C3
6	C-237-1	CH04	C3
7	C-237-1	CH05	D3
8	C-237-1	CH06	E3
9	C-237-1	CH07	E3
10	C-237-1	CH08	F3
11	C-237-1	CH09	G3
12	C-237-1	CH10	G3
13	C-314-10	CH11	A4
14	C-237-1	CH12	A4
15	C-237-1	CH13	B4
16	C-237-1	CH14	C4
17	C-237-1	CH15	C4
18	C-237-1	CH16	E4
19	C-237-1	CH17	E4
20	C-237-1	CH18	F4

Figure 6-4. Interconnect Board, Component Location Drawing, Dwg. No. 706-160

911-902

ZONE	LTR	ECO NO	REVISION	DATE
A	B577		RELEASED	09-7-82
B	B722		ADDED C202, 1000pF.	11-11-82
C	B973		MODIFIED ARTWORK TO ACCEPT DS210 REMOTE*	2-2-83
D	0966		CHG'D R208-R209 FROM 62.2K TO 150K.	2-16-83
E	9774		ADDED W202.	1-15-83

**NOTES:**

1. ALL RESISTOR VALUES ARE IN OHMS UNLESS MARKED OTHERWISE. (K-KILOHMS)
2. ALL CAPACITOR VALUES ARE IN MICROFARADS UNLESS NOTED.
3. ○ DENOTES FRONT PANEL CONTROL.
4. ▽ DENOTES DIGITAL COMMON.

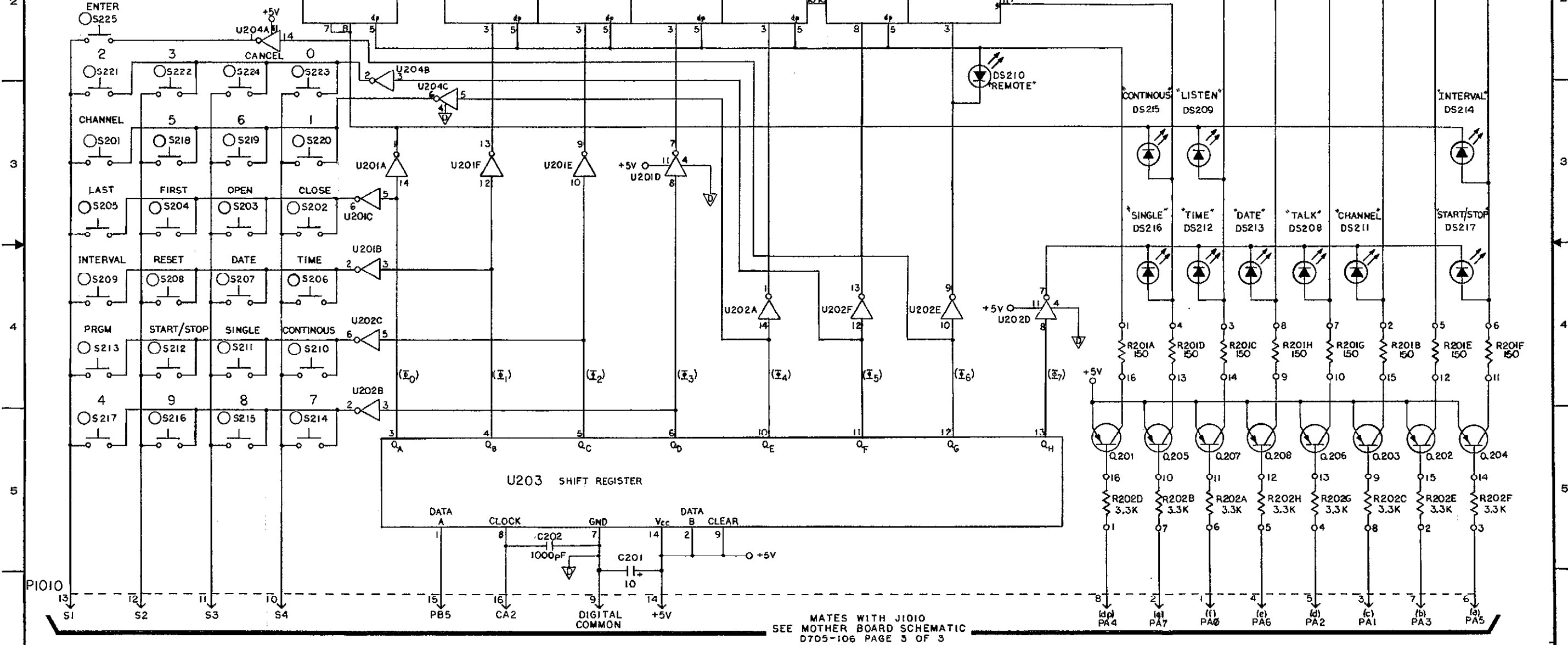

MATES WITH J1010  
SEE MOTHER BOARD SCHEMATIC  
D705-106 PAGE 3 OF 3  
ZONE F6 AND A6

HIGHEST SCHEMATIC DESIGNATIONS USED		SCHEMATIC DESIGNATIONS NOT USED	
C202	S225	PIO1	
R202	Q208	THRU	
PIO10	U204	PIO09	
DS217	W201		

Figure 6-5. Display Board, Schematic Diagram  
Dwg. No. 705-116



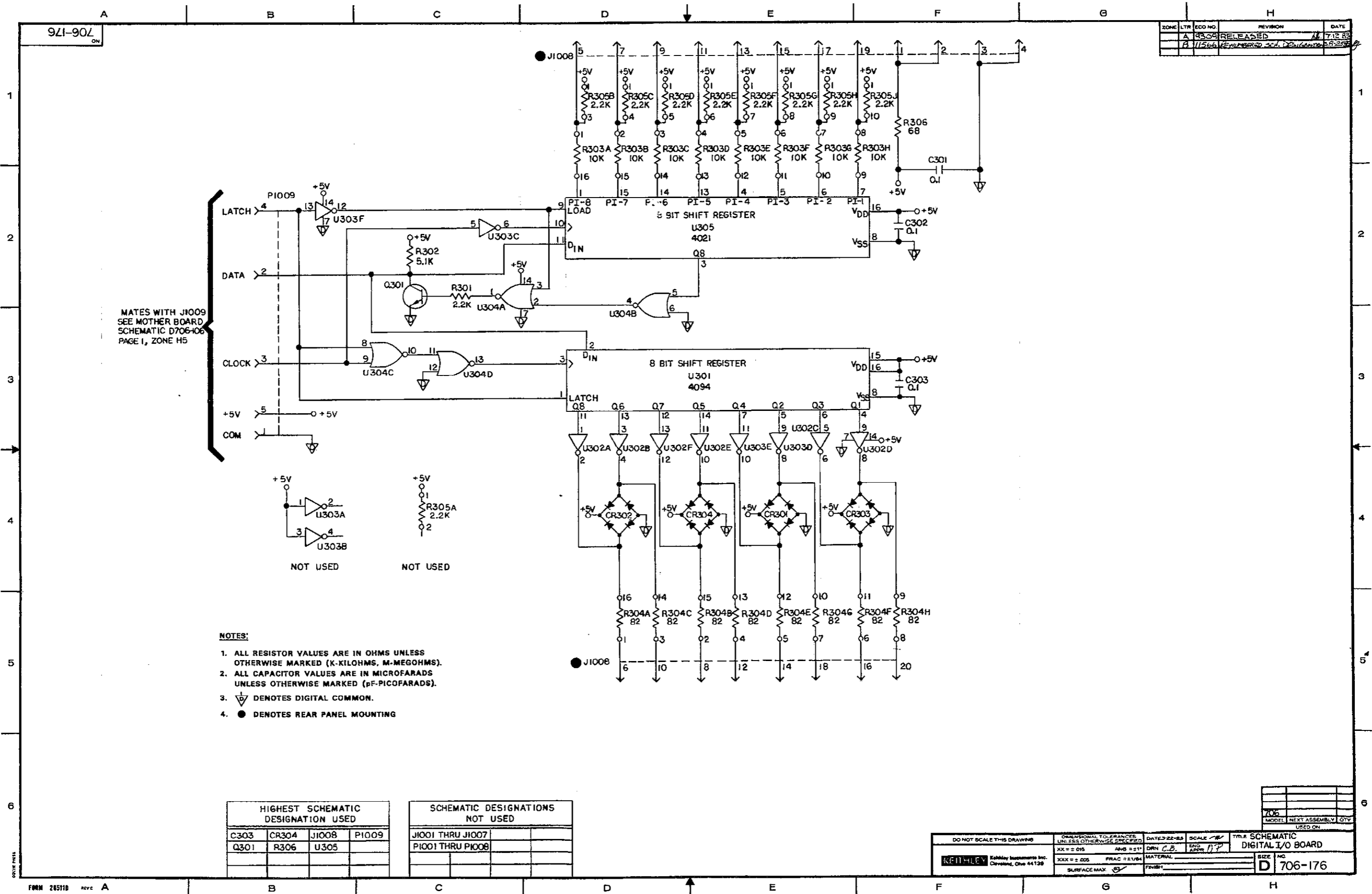

Figure 6-6. Digital I/O Board, Schematic Diagram, Dwg. No. 706-176

ZONE	LTR	ECO NO	REVISION	DATE
A	4300		RELEASED	7-18-65
B	9337		ADDED RV101	7-29-65
C	9404		ADDED CR107	8-21-65
D	9798		REVISED PER NEW POWER SUPPLY	8-30-64
E	10535		REVISED PER NEW POWER SUPPLY	5-20-65

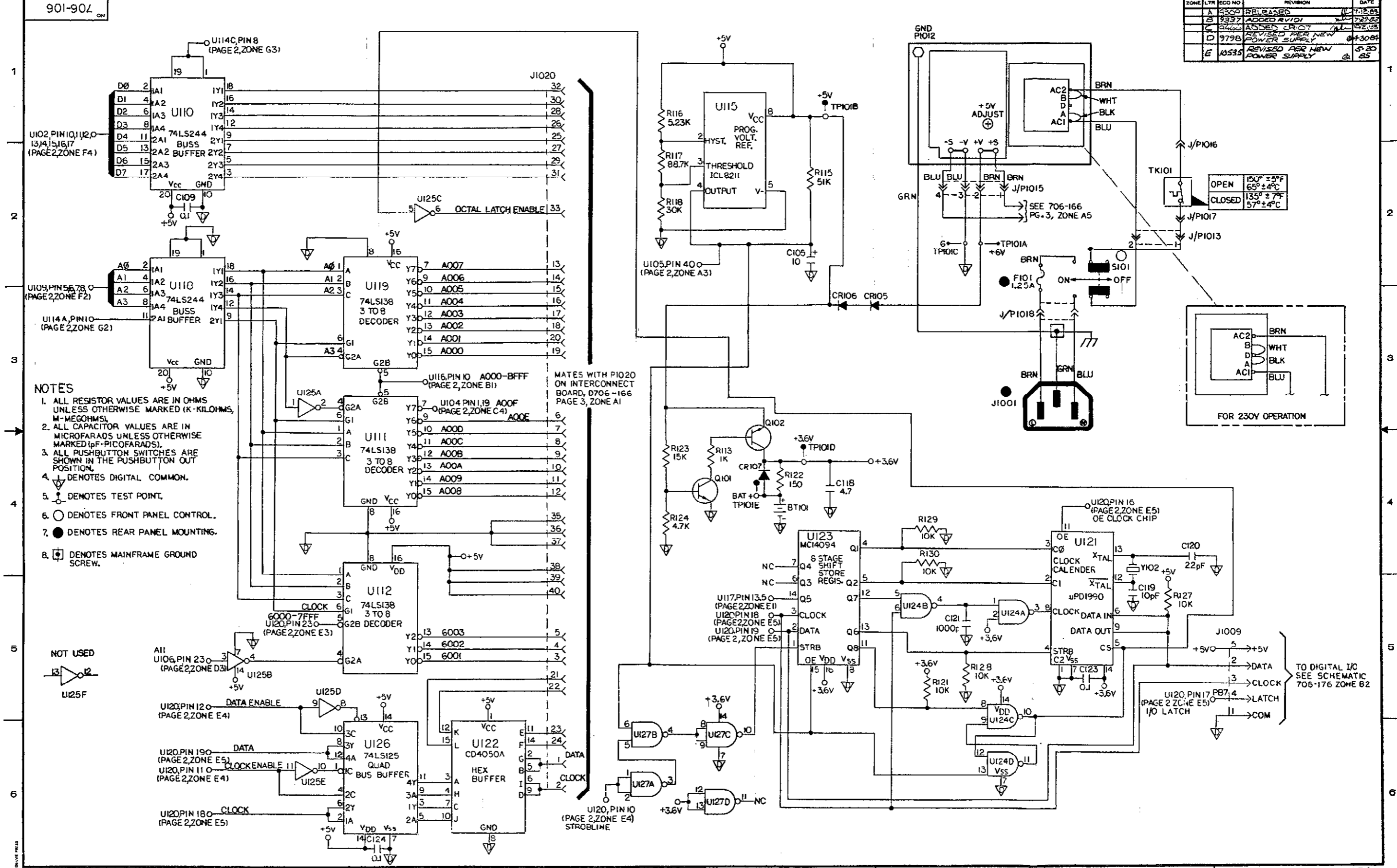
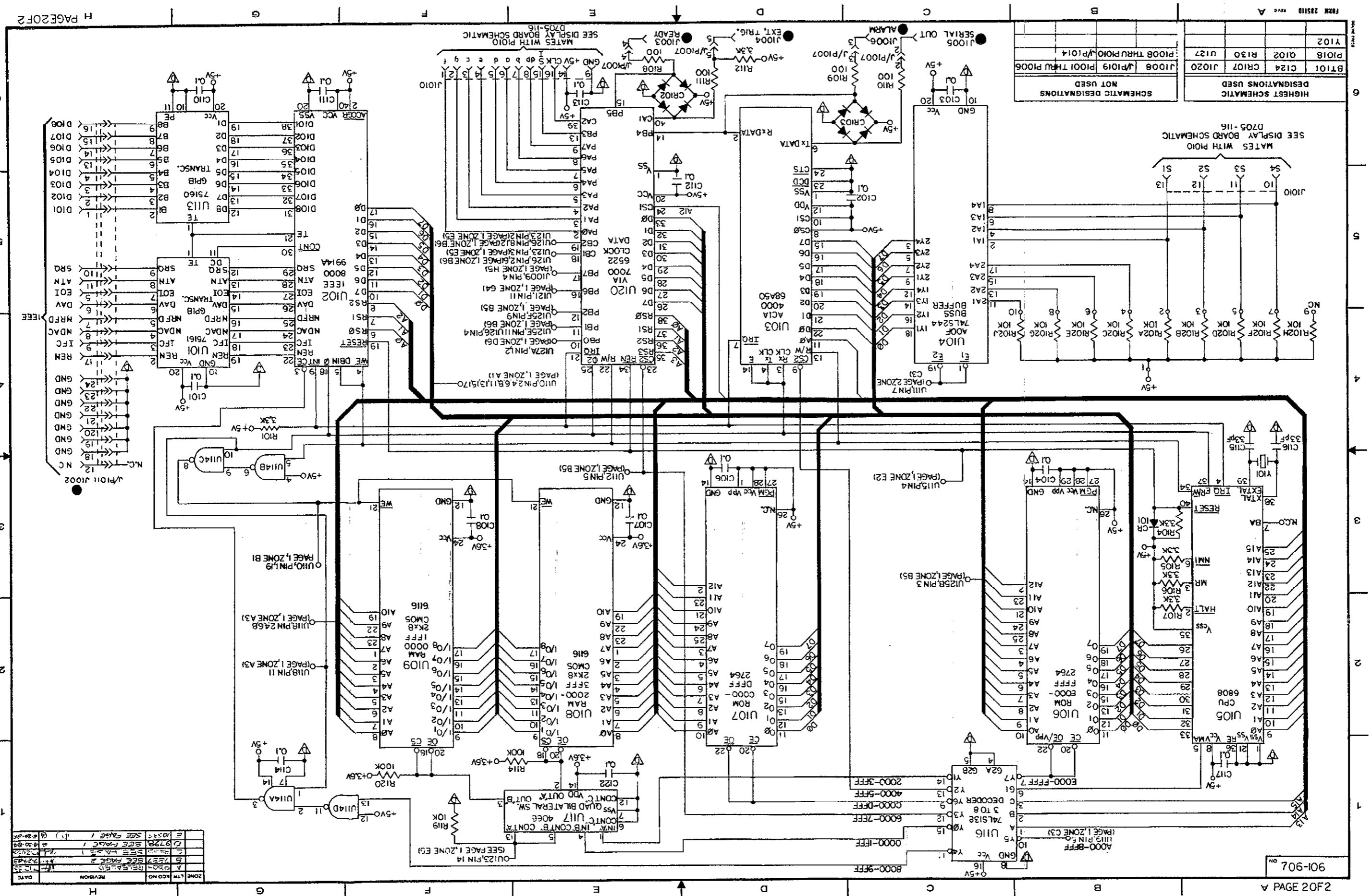

Figure 6-7. Mother Board, Schematic Diagram, Dwg. No. 706-106 (sheet 1 of 2)

Figure 6-7. Mother Board, Schematic Diagram, Dwg. No. 706-106 (sheet 2 of 2)



ZONE	REV	DATE
1	1	11/83
2	1	11/83
3	1	11/83
4	1	11/83
5	1	11/83
6	1	11/83
7	1	11/83
8	1	11/83
9	1	11/83
10	1	11/83
11	1	11/83
12	1	11/83
13	1	11/83
14	1	11/83
15	1	11/83
16	1	11/83
17	1	11/83
18	1	11/83
19	1	11/83
20	1	11/83
21	1	11/83
22	1	11/83
23	1	11/83
24	1	11/83
25	1	11/83
26	1	11/83
27	1	11/83
28	1	11/83
29	1	11/83
30	1	11/83
31	1	11/83
32	1	11/83
33	1	11/83
34	1	11/83
35	1	11/83
36	1	11/83
37	1	11/83
38	1	11/83
39	1	11/83
40	1	11/83
41	1	11/83
42	1	11/83
43	1	11/83
44	1	11/83
45	1	11/83
46	1	11/83
47	1	11/83
48	1	11/83
49	1	11/83
50	1	11/83
51	1	11/83
52	1	11/83
53	1	11/83
54	1	11/83
55	1	11/83
56	1	11/83
57	1	11/83
58	1	11/83
59	1	11/83
60	1	11/83
61	1	11/83
62	1	11/83
63	1	11/83
64	1	11/83
65	1	11/83
66	1	11/83
67	1	11/83
68	1	11/83
69	1	11/83
70	1	11/83
71	1	11/83
72	1	11/83
73	1	11/83
74	1	11/83
75	1	11/83
76	1	11/83
77	1	11/83
78	1	11/83
79	1	11/83
80	1	11/83
81	1	11/83
82	1	11/83
83	1	11/83
84	1	11/83
85	1	11/83
86	1	11/83
87	1	11/83
88	1	11/83
89	1	11/83
90	1	11/83
91	1	11/83
92	1	11/83
93	1	11/83
94	1	11/83
95	1	11/83
96	1	11/83
97	1	11/83
98	1	11/83
99	1	11/83
100	1	11/83

HIGHEST SCHEMATIC DESIGNATIONS USED	
B101	C124 CR107 J1020
P108	Q102 R130 U127
Y102	

SCHEMATIC DESIGNATIONS NOT USED	
J1008	/P1019 P1001 THRU P1006
P1008	THRU P1010 /P1014
Y102	

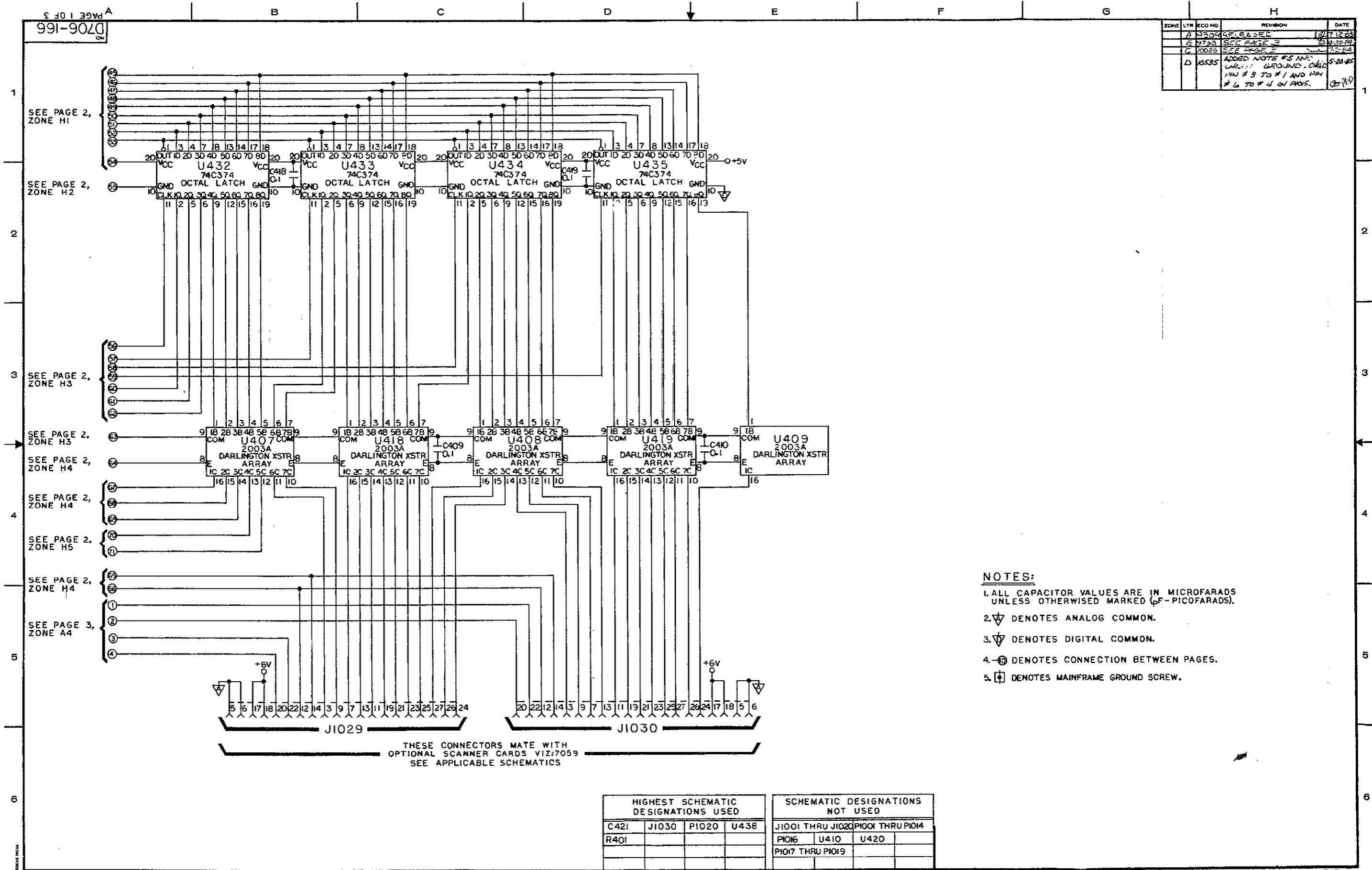
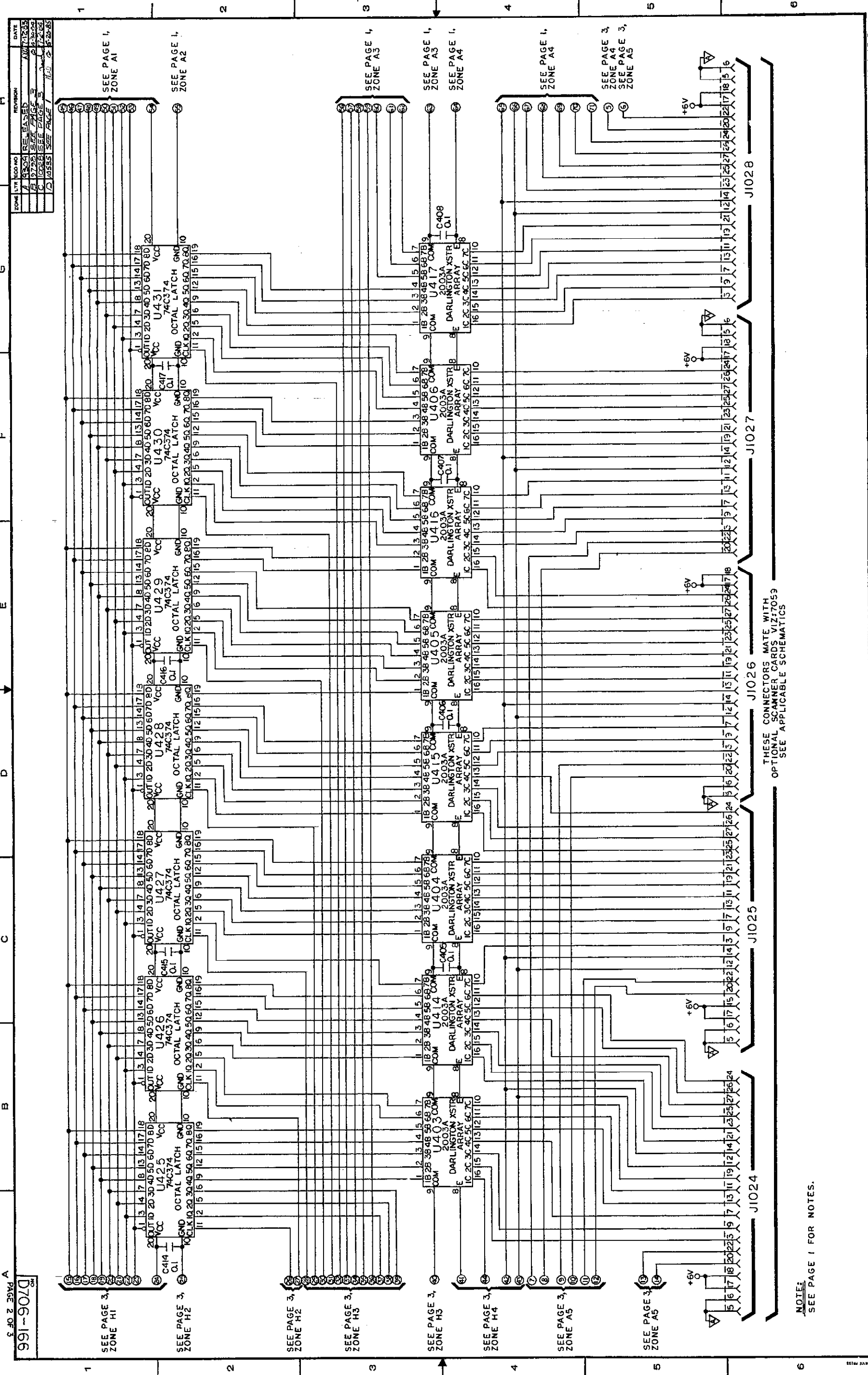

Figure 6-8. Interconnect Board, Schematic Diagram, Dwg. No. 706-166 (sheet 1 of 3)



991-9070  
 3 50 2 39V A

NOTE:  
 SEE PAGE 1 FOR NOTES.

THESE CONNECTORS MATE WITH  
 OPTIONAL SCANNER CARDS VIZ: 7059  
 SEE APPLICABLE SCHEMATICS

FBI 245110

H PAGE 2 OF 3

Figure 6-8. Interconnect Board, Schematic Diagram, Dwg. No. 706-166 (sheet 2 of 3)

6-27/6-28

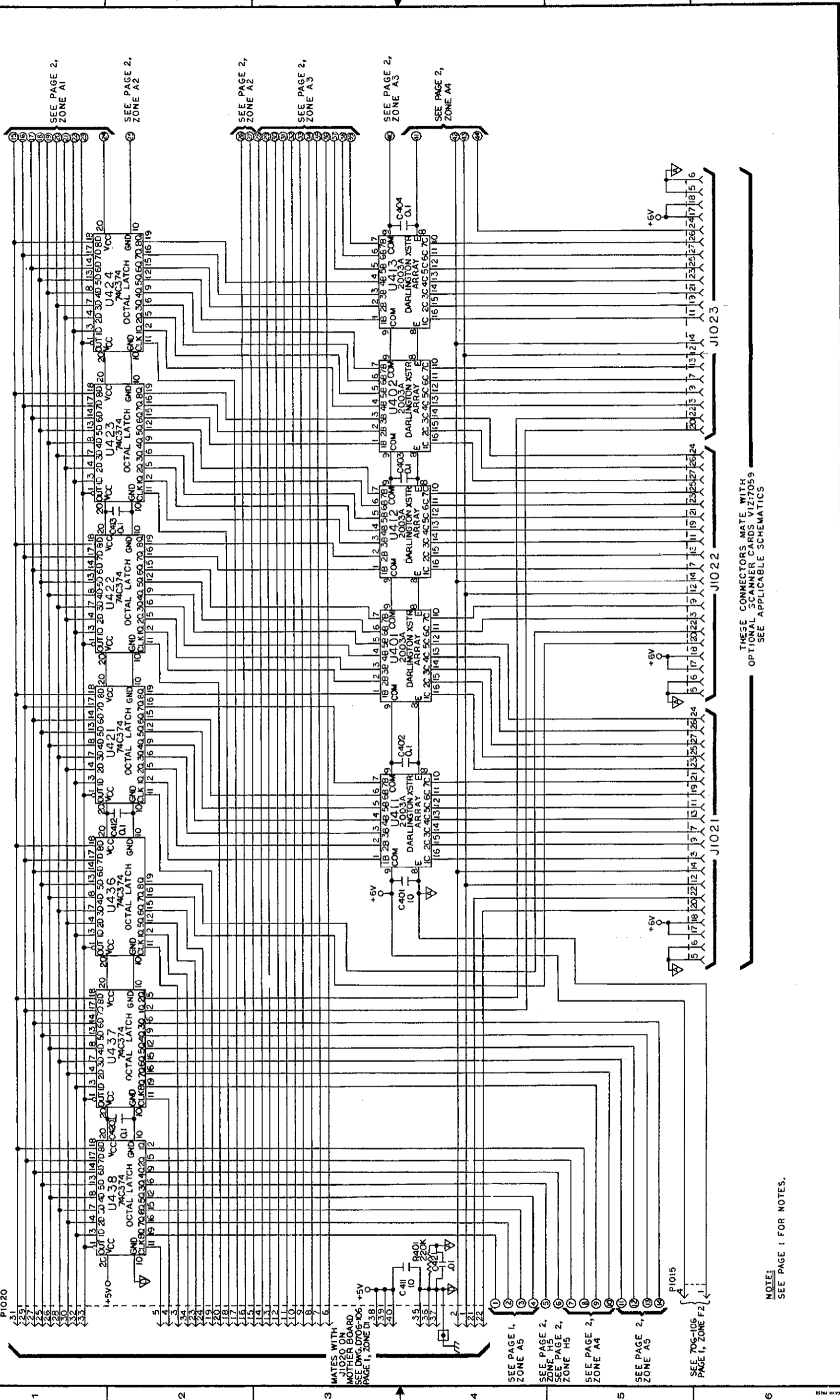

1 2 3 4 5 6

SEE PAGE 2, ZONE A1  
 SEE PAGE 2, ZONE A2  
 SEE PAGE 2, ZONE A2  
 SEE PAGE 2, ZONE A3  
 SEE PAGE 2, ZONE A3  
 SEE PAGE 2, ZONE A4

J1020 J1021 J1022 J1023

NOTE: SEE PAGE 1 FOR NOTES.

THESE CONNECTORS MATE WITH OPTIONAL SCANNER CARDS VIZ:7059 SEE APPLICABLE SCHEMATICS

DATE: 7/18/55  
 REVISION: 1  
 LHM: 1000  
 ZONE: 1  
 SEE PAGE 1, (A) 1, 2, 3, 4, 5, 6, 7, 8, 9, 10, 11, 12, 13, 14, 15, 16, 17, 18, 19, 20, 21, 22, 23, 24, 25, 26, 27, 28, 29, 30, 31, 32, 33, 34, 35, 36, 37, 38, 39, 40, 41, 42, 43, 44, 45, 46, 47, 48, 49, 50, 51, 52, 53, 54, 55, 56, 57, 58, 59, 60, 61, 62, 63, 64, 65, 66, 67, 68, 69, 70, 71, 72, 73, 74, 75, 76, 77, 78, 79, 80, 81, 82, 83, 84, 85, 86, 87, 88, 89, 90, 91, 92, 93, 94, 95, 96, 97, 98, 99, 100

FORM 285110 REV. A

Figure 6-8. Interconnect Board, Schematic Diagram, Dwg. No. 706-166 (sheet 3 of 3)



# Service Form

Model No. \_\_\_\_\_ Serial No. \_\_\_\_\_ Date \_\_\_\_\_

Name and Telephone No. \_\_\_\_\_

Company \_\_\_\_\_

List all control settings, describe problem and check boxes that apply to problem. \_\_\_\_\_

\_\_\_\_\_

- |  |  |  |
|--|--|--|
| <input type="checkbox"/> Intermittent            | <input type="checkbox"/> Analog output follows display   | <input type="checkbox"/> Particular range or function bad; specify |
| <input type="checkbox"/> IEEE failure            | <input type="checkbox"/> Obvious problem on power-up     | <input type="checkbox"/> Batteries and fuses are OK                |
| <input type="checkbox"/> Front panel operational | <input type="checkbox"/> All ranges or functions are bad | <input type="checkbox"/> Checked all cables                        |

Display or output (check one)

- |                                   |  |
|-----------------------------------|--|
| <input type="checkbox"/> Drifts   | <input type="checkbox"/> Unable to zero              |
| <input type="checkbox"/> Unstable | <input type="checkbox"/> Will not read applied input |
| <input type="checkbox"/> Overload |  |

Calibration only       Certificate of calibration required

Data required

(attach any additional sheets as necessary)

Show a block diagram of your measurement system including all instruments connected (whether power is turned on or not). Also, describe signal source.

Where is the measurement being performed? (factory, controlled laboratory, out-of-doors, etc.)

\_\_\_\_\_

What power line voltage is used? \_\_\_\_\_ Ambient temperature? \_\_\_\_\_ °F

Relative humidity? \_\_\_\_\_ Other? \_\_\_\_\_

Any additional information. (If special modifications have been made by the user, please describe.)

\_\_\_\_\_

Be sure to include your name and phone number on this service form.

**KEITHLEY**

**Keithley Instruments, Inc.**  
28775 Aurora Road  
Cleveland, Ohio 44139

Printed in the U.S.A.